

# MFPA Leipzig GmbH

Testing, Inspection and Certification Authority for  
Construction Products and Construction Types

Leipzig Institute for Materials Research and Testing  
Business Division III - Structural Fire Protection

Dipl.-Ing. Michael Juknat

Work Group 3.2 - Fire Behaviour of Building Components and special  
Constructions

Dipl.-Ing. S. Bauer

Tel.: +49 (0) 341-6582-194

s.bauer@mfpa-leipzig.de

---

## Notice of extension of the validity of the Advisory Opinion no. GS 3.2/14-175-4

2 March 2020

No. Copy 1

---

Subject matter: Advisory Opinion on the strength and deformation behaviour of the fischer FUS channel and of the fischer cantilever arm FCA in the sizes 41 and 62.

Client: fischerwerke GmbH & Co. KG  
Klaus-Fischer-Straße 1  
72178 Waldachtal

Date of order: 10 February 2020

Person in charge: Dipl.-Ing. S. Bauer

This notice consists of two pages. It is only valid in conjunction with the above-mentioned Advisory Opinion and may only be used in conjunction with it.

---

Dieses This document may only be reproduced in its unabbreviated form. All publication, even in excerpts, requires the prior written permission of MFPA Leipzig GmbH. The legal binding form is the written German form with the original signatures and original stamp of the authorized signatory / signatories. General terms and conditions of MFPA Leipzig GmbH are valid.

---

Gesellschaft für Materialforschung und Prüfungsanstalt für das  
Bauwesen Leipzig mbH (MFPA Leipzig GmbH)

Head Office: Hans-Weigel-Str. 2b – 04319 Leipzig/Germany  
Managing Director: Dr.-Ing. habil. Jörg Schmidt  
Comm. Register: Local Court Leipzig HRB 17719  
VAT-ID: DE 813200649  
Tel.: +49 (0) 341-6582-0  
Fax: +49 (0) 341-6582-135

## 1 Request

MFPA Leipzig GmbH was commissioned on 10 February 2020 to extend the Advisory Opinion no. GS 3.2/14-175-4 of 17 April 2015.

## 2 Principles

- [1] RAL-GZ 656: Fire-tested pipe supports from May 2010 of the Deutsche Institut für Gütesicherung und Kennzeichnung e.V. (German Institute for Quality Assurance and Certification).
- [2] Technical data sheets of the FUS channel from fischerwerke GmbH & Co. KG.
- [3] Test Report PB 3.2/14-175-3 from 17.04.2015 of MFPA Leipzig GmbH: FUS channels in the sizes 41 and 62 – test in compliance with RAL-GZ 656 (May 2010) to determine the strength and deformation behaviour.
- [5] DIN EN 1993-1-2:2010-12 Eurocode 3: Design of steel structures - Part 1-2: General rules - Structural fire design
- [6] Model guideline for technical fire protection requirements on conduit systems (Model Conduit Systems Guideline MLAR) as amended on 17.11.2005
- [7] Test Report (3147/252/12) – CM from 05.10.2012 of MPA Braunschweig: Testing and evaluation of fischer FUS channel systems consisting of fischer FUS channel 41/2,5 and fischer cantilever arms FCA 41 in conjunction with fischer sliding nuts FCN Clix with respect to the fire behaviour with a flame impingement acc. to the standard temperature-time curve pursuant to DIN EN 1363-1: 1999-10.
- [8] Supplement to test report (3147/252/12) - CM of 05.10.2012 of MPA Braunschweig: Testing and evaluation of fischer FUS channel systems consisting of fischer FUS channel 41/2.5 and fischer cantilever arms FCA 41 in conjunction with fischer sliding nuts FCN Clix with respect to the fire behaviour with a flame impingement acc. to the standard temperature-time curve pursuant to DIN EN 1363-1: 1999-10.

## 3 Validity

This notice extends the validity of the Advisory Opinion no. GS 3.2/14-175-4 of 17 April 2015.

The validity of the Advisory Opinion is extended until 16 April 2025.

The results of the tests exclusively relate to the items tested. This document does not replace a certificate of conformity or suitability according to national and European building codes.

Leipzig, 2 March 2020



\_\_\_\_\_  
Dipl.-Ing. M. Juknat  
Head of Business Division



\_\_\_\_\_  
Dipl.-Ing. S. Bauer  
Testing Engineer



# Mfpa Leipzig GmbH

Testing, Inspection and Certification Authority for  
Construction Products and Construction Types

Leipzig Institute for Materials Research and Testing  
Business Division III - Structural Fire Protection

Dipl.-Ing. Sebastian Hauswaldt

Work Group 3.2 - Fire Behaviour of Building Components  
and special Constructions

Dipl.-Wirtsch.-Ing. S. Kramer

Tel.: +49 (0) 341 - 6582-194

kramer@mfpa-leipzig.de

---

## Advisory Opinion No. GS 3.2/14-175-4

17 April 2015

No. Copy 1

---

*Translation of the original German document GS 3.2/14-175-4*

**Subject matter:** Advisory opinion on the strength and deformation behaviour of the **fischer FUS channel and of the fischer cantilever arm FCA** in the sizes 41 and 62.

**Client:** **fischerwerke GmbH & Co. KG**  
Klaus-Fischer-Straße 1  
D - 072178 Waldachtal

**Date of order:** 22. October 2014

**Person in charge:** Dipl.-Wirtsch.-Ing. Sabine Kramer

**Identification:** none

**Validity:** 16. April 2020

This document consists of 8 pages and 1 Annex.

---

This document may only be reproduced in its unabbreviated form. All publication, even in excerpts, requires the prior written permission of Mfpa Leipzig GmbH. The legal binding form is the written German form with the original signatures and original stamp of the authorized signatory / signatories.

General terms and conditions of MPFA Leipzig GmbH are valid.



Test laboratory accredited by DAkkS GmbH according to DIN EN ISO/IEC 17025. The accreditation only applies to the test methods listed in the certificate (in this document marked with \*) which can be seen on [www.mfpa-leipzig.de](http://www.mfpa-leipzig.de)

Gesellschaft für Materialforschung und Prüfungsanstalt für das Bauwesen Leipzig mbH (Mfpa Leipzig GmbH)

Head Office: Hans-Weigel-Str. 2b – 04319 Leipzig/Germany  
Managing Director: Prof. Dr.-Ing. Frank Dehn  
Comm. Register: Local Court Leipzig HRB 17719  
VAT-ID: DE 813200649  
Tel.: +49 (0) 341 - 6582-0  
Fax: +49 (0) 341 - 6582-135

## 1 Objective and request

MFPA Leipzig GmbH was commissioned on 22. October 2014 by fischerwerke GmbH & Co. KG to prepare an advisory opinion on the strength and deformation behaviour of the FUS channel with a exposure to fire and anchorage in a reinforced concrete base

## 2 Principles and documents for the advisory opinion

The following documents were taken into account for the advisory opinion

- [1] RAL-GZ 656 Fire-tested pipe support from May 2010 of the Deutschen Instituts für Gütesicherung und Kennzeichnung e.V. (German Institute for Quality Assurance and Certification).
- [2] Technical data sheets for the FUS channel from the firm of fischerwerke GmbH & Co. KG.
- [3] Test report PB 3.2/14-175-3 from 17.04.2015 of MFPA Leipzig GmbH: FUS channels in the sizes 41 and 62 – test in compliance with RAL-GZ 656 (May 2010) to determine the strength and deformation behaviour.
- [5] DIN EN 1993-1-2:2010-12 Eurocode 3: Design of steel structures - Part 1-2: General rules - Structural fire design
- [6] Model guideline for technical fire protection requirements on conduit systems (Model Conduit Systems Guideline MLAR) as amended on 17.11.2005
- [7] Test report (3147/252/12) – CM from 05.10.2012 of the MPA Braunschweig: testing and evaluation of fischer FUS channel systems consisting of fischer FUS channel FUS 41/2.5 and fischer cantilever arms FCA 41 in conjunction with fischer sliding nuts FCN Clix with respect to the fire behaviour with a flame impingement acc. to the standard temperature-time curve pursuant to DIN EN 1363-1: 1999-10.
- [8] Supplement to the test report (3147/252/12) – CM from 05.10.2012 of the MPA Braunschweig: testing and evaluation of fischer FUS channel systems consisting of fischer FUS channels FUS 41/2.5 and fischer cantilever arms FCA 41 in conjunction with fischer sliding nuts FCN Clix with respect to the fire behaviour with a flame impingement acc. to the standard temperature-time curve pursuant to DIN EN 1363-1: 1999-10.

## 3 Description of the construction

The tested channels FUS 41/2.5 and FUS 62/2.5 as well as the cantilever arm FCA 62 is a supporting system of galvanised steel. They are mainly used to fasten pipes in conjunction with the corresponding pipe clamps or to support electrical installation conduits with a predominantly static load. Both the channels and the cantilever arms are profiled steel sections of cold-formed, galvanised steel strip. The FCA also have a base plate that is used to fasten the cantilever arm to wall elements. Various loads and suspension combinations were tested.

Further details of the material, dimensions of the tested samples as well as the test conditions and observations can be found in the corresponding test reports [3] and [7].



#### 4 Fire protection assessment

The permissible loads are determined on the basis of GAL-GZ 656 Fire-tested pipe support: 2010-05 [1]. The following characteristic parameters for the load under tension can be quoted for the FUS channel on this basis (Table 1).

**Table 1** Characteristic maximum tension resistance for the FUS channel

Channel	Span [mm]	Suspended height [mm]	Type of suspension	Load	Permissible maximum load as a function of the fire-resistance period			
					30	60	90	120
					Max. F [kN]			
FUS 41/2,5	400	0	GS	EL	1.20	0.79	0.61	0.50
				ML	1.20	0.79	0.61	0.50
	400	500	GS	GL	1.20	0.79	0.61	0.50
				EL	2.40**	1.33**	0.92**	0.72**
				ML	2.40**	1.33**	0.92**	0.72**
	700	500	GS	GL	3.00**	2.10**	1.41**	1.06**
				EL	1.61**	1.04**	0.80**	0.67**
				ML	1.61**	1.04**	0.80**	0.67**
	1250	500	GS	GL	2.44**	1.57**	1.21**	1.00**
	FUS 62/2,5	400	0	GS	GL	3.29	1.81	1.27
EL					1.76	1.06	0.78	0.62
400		0	GS	ML	1.76	1.06	0.78	0.62
				GL	1.76	1.06	0.78	0.62
1000		500	GS	EL	2.27	1.31	0.93	0.72
				ML	2.52	1.60	1.21	0.99
				GL	2.52	1.60	1.21	0.99
1250		500	GS	GL	2.41	1.65	1.31	1.11
1000		500	FUS 41/2,5	EL	1.33	0.87	0.68	0.57
				ML	1.92	1.34	1.08	0.92
	GL			1.92	1.34	1.08	0.92	
FCA 62/2,5	960	500	GS	ML	4.30	2.14	1.39	1.01
				GL	4.30	2.14	1.39	1.01

\*no data possible

\*\*values taken from [7]

The graphical analysis of the test results as well as the corresponding fire-resistance period can be found in Annex 1. The maximum loads quoted relate to a complete failure of the relevant construction. Any serious deformations that suddenly occur beforehand are ignored.

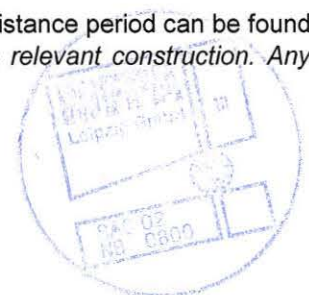

## 5 Restrictions on use

The foregoing assessment of the FUS channel as well as the suspension cantilever arm FCA excludes their use for cable systems with integrated functional integrity and electric conduits acc. to DIN 4102-12: 1998-11. Further assessments and proofs are needed with respect to the overall system for such applications.

The junctions/intersections must be designed in the manner shown in the test report. In particular, HK 41 channel washer of at least size M10 have to be used on both sides with corresponding nuts (strength class  $\geq 8$ ) if suspended with threaded rods (at least M10, strength class  $\geq 4.8$ ). The FUS channel should be arranged in this case so that the connectors FCN Clix P are only used in the channel profiles that are open at the top. The connectors FCN Clix P are locked with channel washers HK 41 and MU threaded nuts in this setup and may only be used to support loads.

The directly mounted FUS channel should be arranged so that the connectors FCN Clix P are only used in the channel profiles that are open at the bottom. The connectors FCN Clix P are locked with channel washers HK 41 and MU threaded nuts in this setup.

In the case of a suspension with FUS 41/2.5, the FUS channels are to be arranged so that the connectors FCN Clix P are only used in the channel profiles that are open at the top and side. The connectors FCN Clix P are locked with the UWS angles and SKS hexagon bolts in this setup.

If pipe clamps or other installations are mounted below the channel they should be fastened by fisher channel washers arranged on both sides as well as the corresponding nuts and threaded rods of the desired fire-resistance period.

If the FUS channels are used in the intermediate ceiling area of suspended counter ceiling constructions that are relevant with respect to fire protection, a minimum gap "a" is defined on the safe side between the upper side of the suspended ceiling and the lower side of the channels. The goal is to rule out any negative influence of the counter ceiling construction due to temperature-related vertical deformations of the channels as well as the linear changes of the threaded rods.

It is assumed that the maximum protrusion of the nuts and threaded rods below the channels is less than 30 mm. It also has to be ensured that both the channels as well as the suspension cantilever arms protrude at least 50 mm from the central axis of the vertical fastening to the lateral edge of the channel.

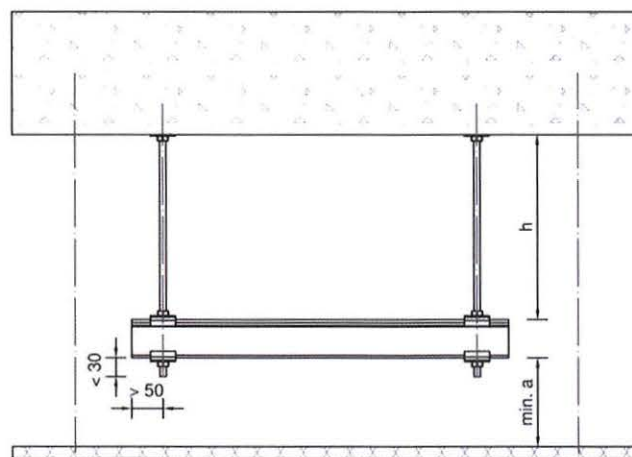
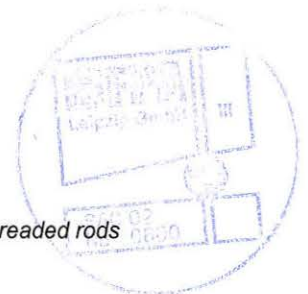
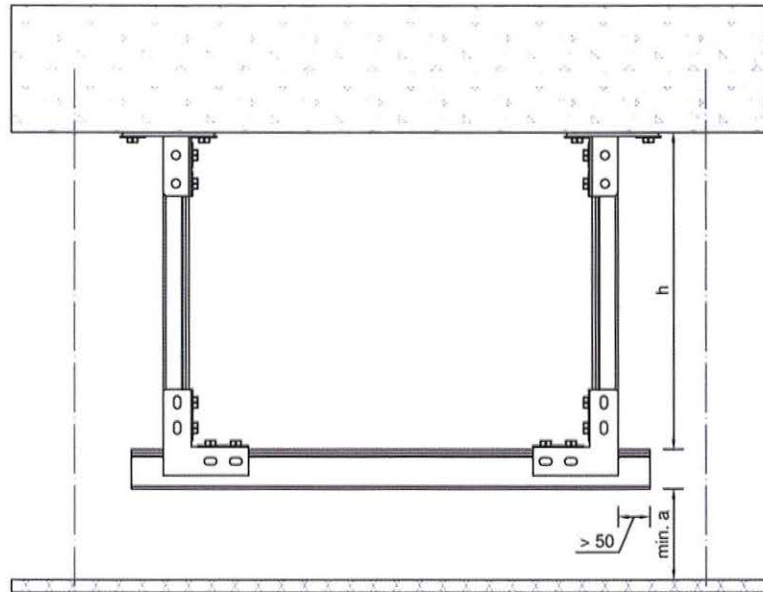
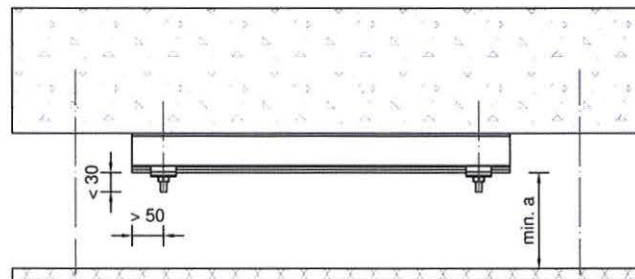

Figure 1 Illustration of use in the intermediate ceiling area – suspended with threaded rods

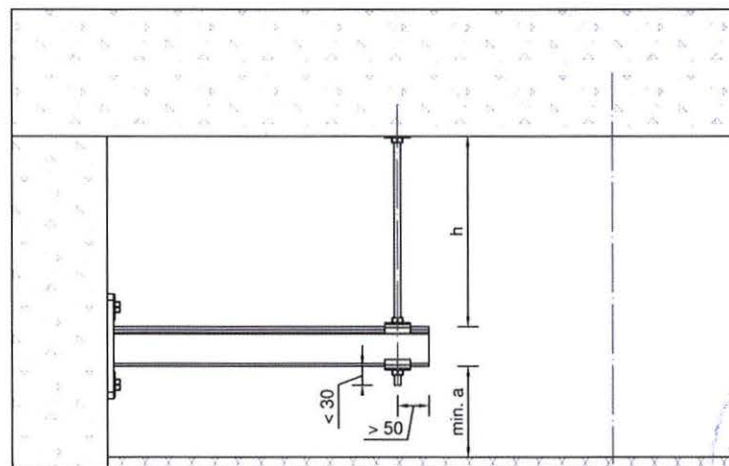



**Figure 2** *Illustration of use in the intermediate ceiling area – suspended with channels*



**Figure 3** *Illustration of use in the intermediate ceiling area – direct fastening to the ceiling*



**Figure 4** *Illustration of use of the cantilever arm FCA in the intermediate ceiling area*



The minimum gaps "min a" are shown in Table 2. The values shown here take into account the temperature-related change in length of the threaded rods used for suspension purposes as well as the maximum vertical deformations as a function of the span of the channels, the type of suspension and the arrangement of the load.

The minimum gaps "min a" quoted here to components below this that are relevant for fire protection correspond to the maximum safety gaps assuming that the maximum permissible loads under exposure to fire corresponding to Table 1 act on the system.

Since the useful height in the intermediate ceiling area in practice is often limited, the aforementioned maximum safety gaps may not always be able to be realised. For this reason, reduced loads are determined for the systems to be assessed which guarantee that with an exposure to fire acc. to the standard temperature-time curve for 30 minutes, the minimum gap "min a" = 50 mm is not exceeded.

**Table 2** Minimum gaps "min a" when the channels are used in the intermediate ceiling area of counter ceilings relevant for fire protection and maximum load for which the maximum vertical deformation of the overall construction is  $\leq 50$  mm for a fire-resistance period of 30 minutes

Channel	Span [mm]	Suspended height [mm]	Type of suspension	Load	Minimum gaps "min a" at maximum load [mm]	Maximum load for a fire-resistance period F30 and "min a" $\leq 50$ mm [kN]
FUS 41/2,5	400	0	GS	EL	57	1.20
	400	0	GS	ML	57	1.20
				GL	57	1.20
	400	500	GS	EL	278**	0.90**
				ML	278**	0.90**
				GL	258**	1.50**
	700	500	GS	EL	320**	0.00**
				ML	320**	0.00**
				GL	299**	0.60**
	1250	500	GS	GL	468	-*
FUS 62/2,5	400	0	GS	EL	25	1.76
	400	0	GS	ML	25	1.76
				GL	25	1.76
	1000	500	GS	EL	460	-*
				ML	661	0.55
				GL	661	0.55
	1250	500	GS	GL	592	0.50
	1000	500	FUS 41/2,5	EL	369	0.57
				ML	649	0.62
				GL	649	0.62

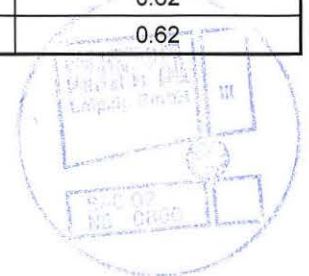



Continued Table 2

Channel	Span [mm]	Suspended height [mm]	Type of suspension	Load	Minimum gaps "min a" at maximum load [mm]	Maximum load for a fire-resistance period F30 and "min a" ≤ 50 mm [kN]
FCA 41/2,5	400	500	GS	EL	237**	0,90**
				ML	237**	0,90**
				GL	237**	1,50**
	700	500	GS	EL	335**	0,00**
				ML	335**	0,00**
				GL	335**	0,60**
FCA 62/2,5	960	500	GS	ML	550	4,30
				GL	550	4,30

\*no data possible

\*\*values taken from [7]

The minimum gap "min a" refers to the deformations of the overall construction consisting of channel and suspension under exposure to fire. Additional deformations, e.g. from the installations (e.g. pipes) have to be investigated separately.

The specified load refers to a central and/or symmetrical arrangement of the loads. If this is not possible in practice the loads have to be reduced so that the maximum steel stresses are not exceeded in the threaded rods.

The loads quoted in Tables 1 and 2 are summations of all single loads. This overall load may not be exceeded with a simultaneous support and suspension at one point where the load is introduced.

## 6 Special notes

The foregoing assessment only applies for the tested FUS channel of galvanised steel that have been installed in accordance with the mounting instructions in the technical data sheets of the firm of fischerwerke GmbH & Co. KG and taking into account the design of the junctions/intersections specified in the test report.

On account of the better high-temperature behaviour of stainless steel, the figures also apply for FUS channels and cantilever arms FCA with the same dimensions of stainless steel A2/A4.

The type of galvanisation has no effect on the fire resistance. This is why the figures also apply for FUS channels and suspension cantilever arms FCA of hot-dip galvanised steel, provided the dimensions of the channels are identical to those of the tested channels.

The assessment only applies in conjunction with the described components and in components that can be classified in at least the fire-resistance class corresponding to the fire-resistance period of the channel constructions.

The channel systems may only be used to fasten installations (e.g. pipes) under a predominantly static load.

The channels have to be fastened to ceiling or wall constructions with fasteners that have corresponding fire protection verification. If connecting to solid structural components it has to be ensured that any loads occurring during a fire can be absorbed.

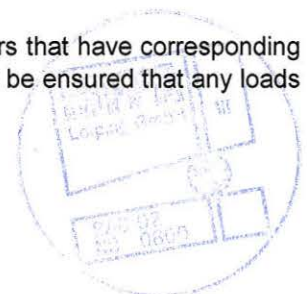



Leipzig, 17 April 2015

Dipl.-Ing. S. Hauswaldt  
*Head of Business Division*

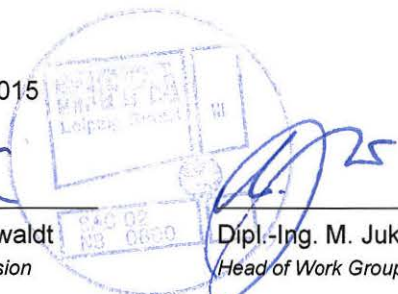

Dipl.-Ing. M. Juknat  
*Head of Work Group*

Dipl.-Wirtsch.-Ing. S. Kramer  
*Testing Engineer*

**Annex 1**      Graphical analysis of the test results

**Fire-resistance period for the combination FUS 41/2.5 – direct – EL with a static span of 400 mm**

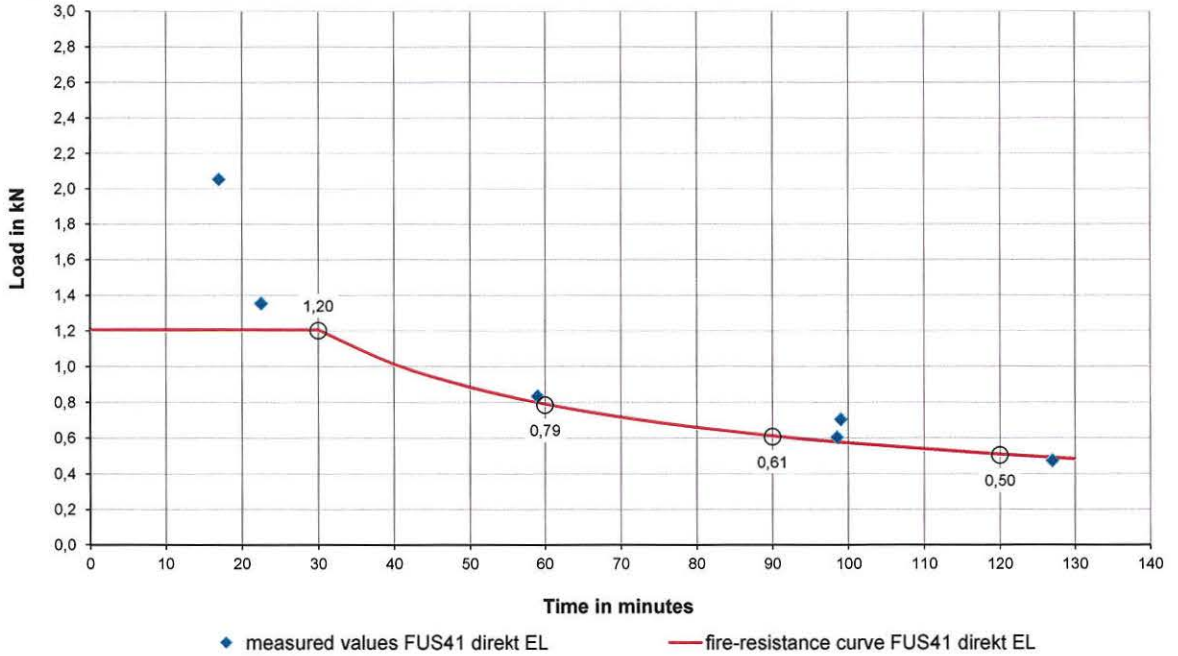

**Load-deformation curve for the combination FUS 41/2.5 – direct – EL with a static span of 400 mm after exposure to fire for 30 minutes**

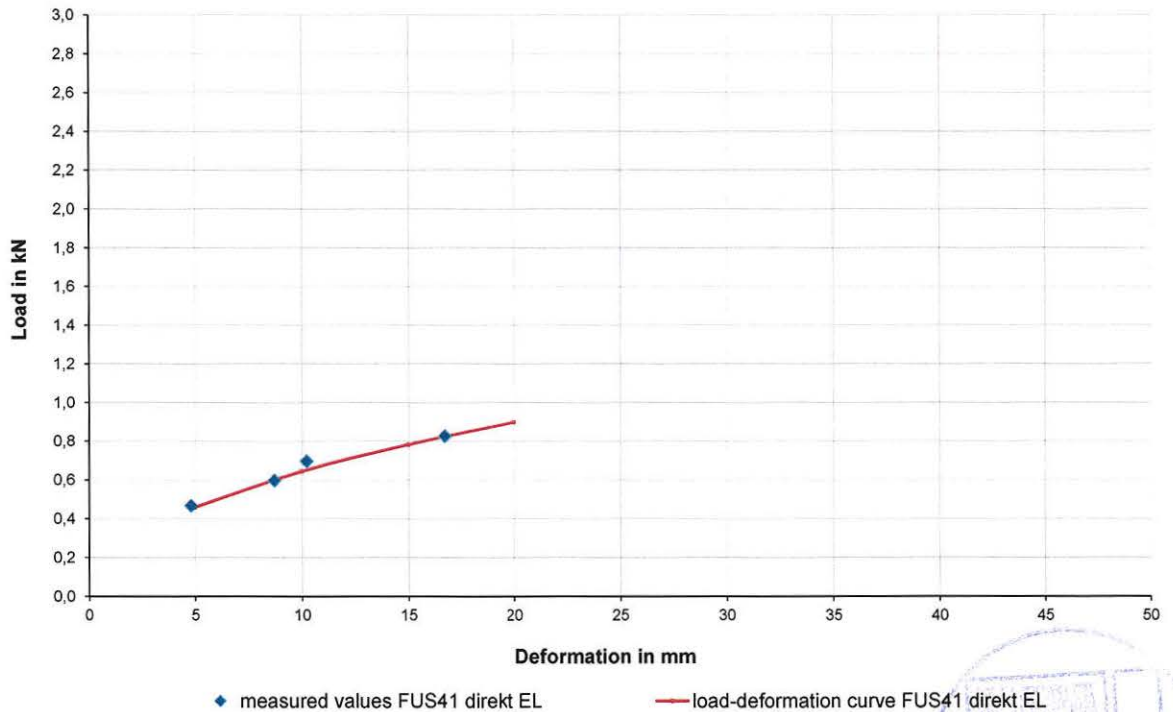

The load-deformation curve shows that even with a maximum load of 1.20 [kN] and exposure to fire for 30 minutes, no deformations greater than 50 mm are to be expected.



**Fire-resistance period for the combination FUS 41/2.5 – GS GL with a static span of 1,250 mm**

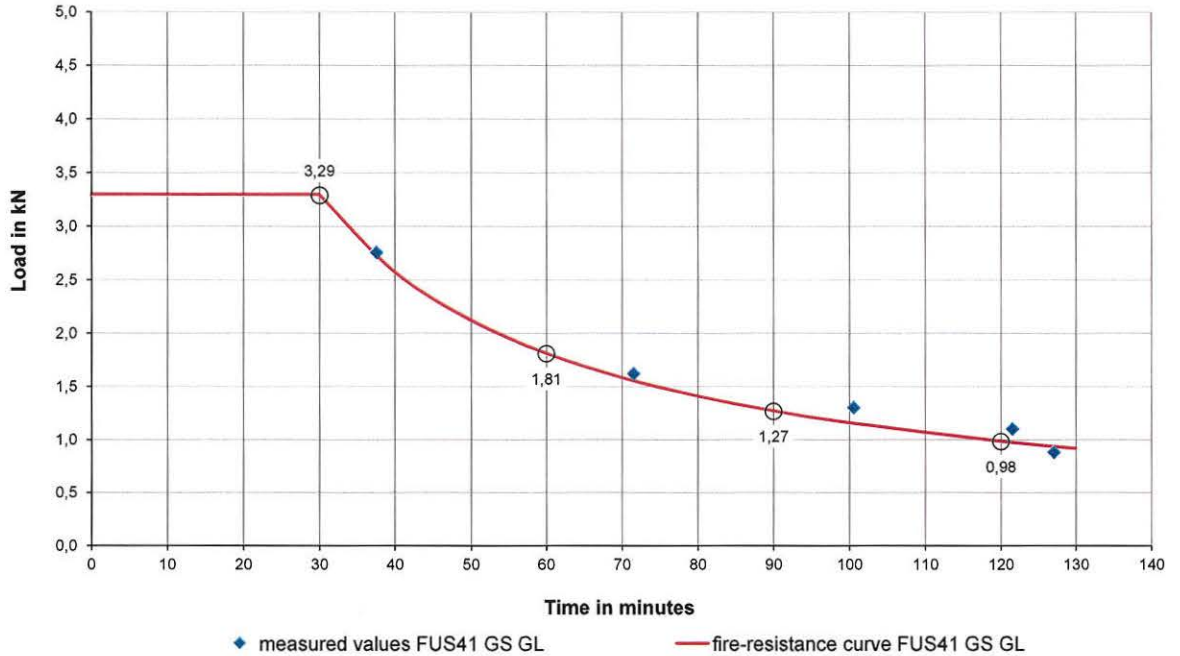

**Load-deformation curve for the combination FUS 41/2.5 – GS – GL with a static span of 1,250 mm after exposure to fire for 30 minutes**

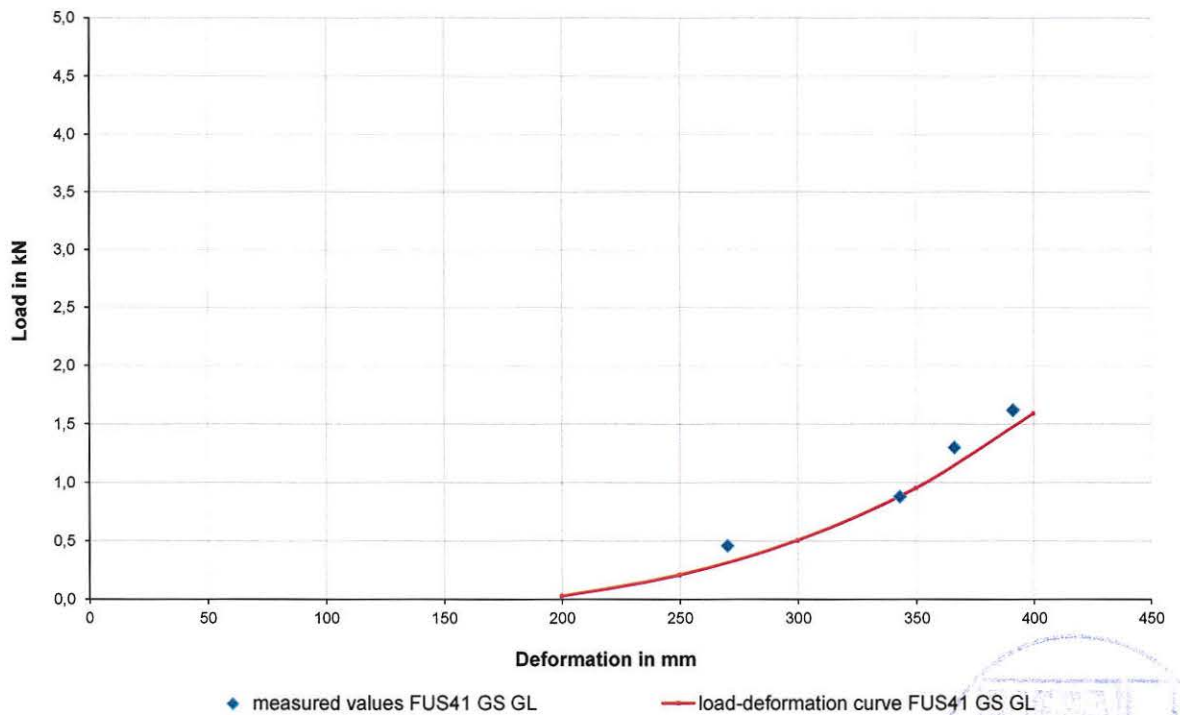

The load-deformation curve shows that the dead weight of the construction already leads to deformations of more than 50 mm after exposure to fire for 30 minutes.



**Fire-resistance period for the combination FUS 62/2.5 – direct – EL with a static span of 400 mm**

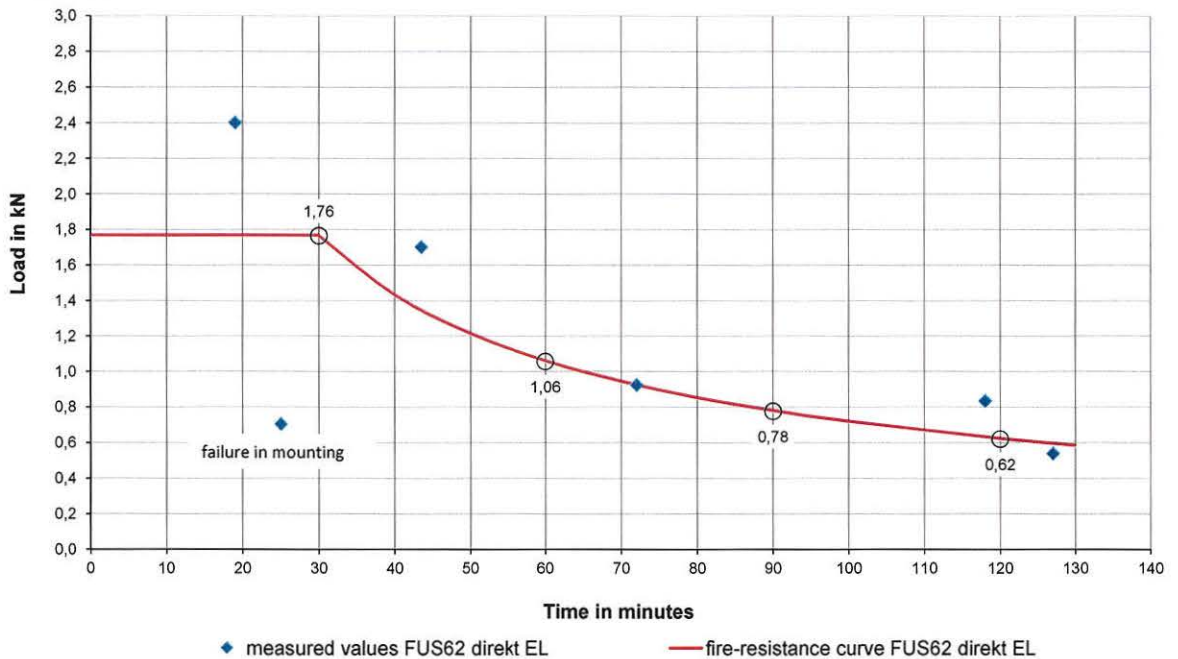

**Load-deformation curve for the combination FUS 62/2.5 – direct – EL with a static span of 400 mm after exposure to fire for 30 minutes**

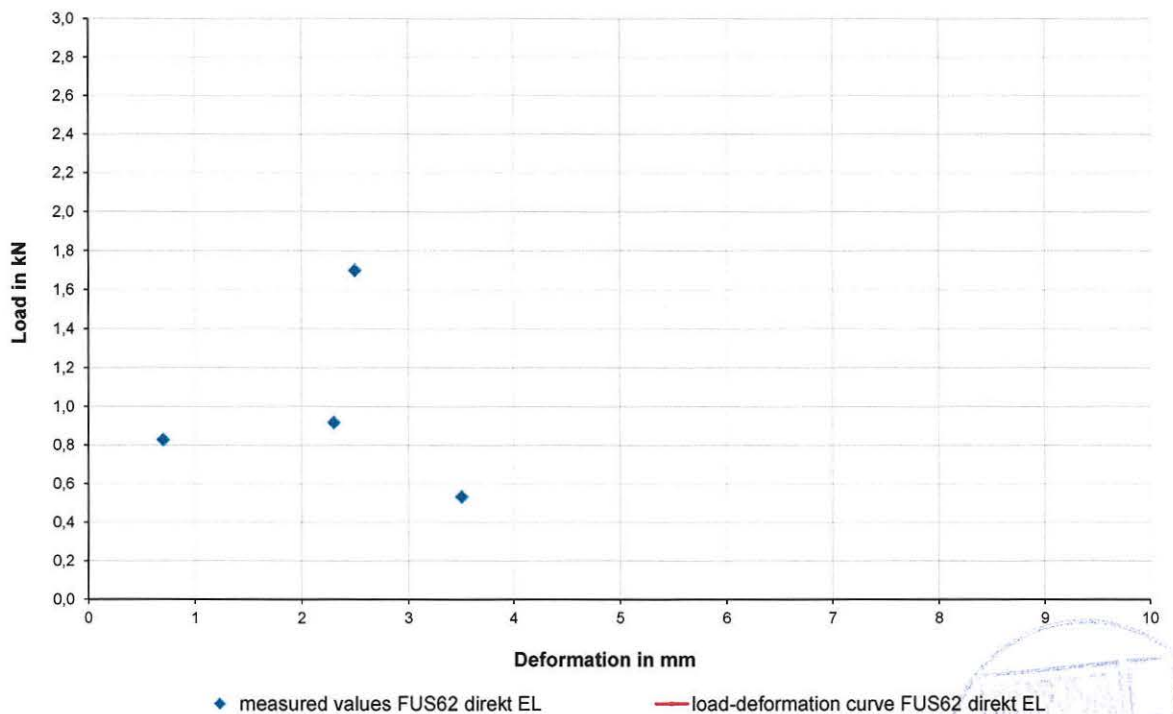

The test results show no clear load-deformation curve. However, even with a maximum load of 1.76 [kN] and exposure to fire for 30 minutes, no deformations greater than 50 mm are to be expected.



**Fire-resistance period for the combination FUS 62/2.5 – GS – EL with a static span of 1,000 mm**

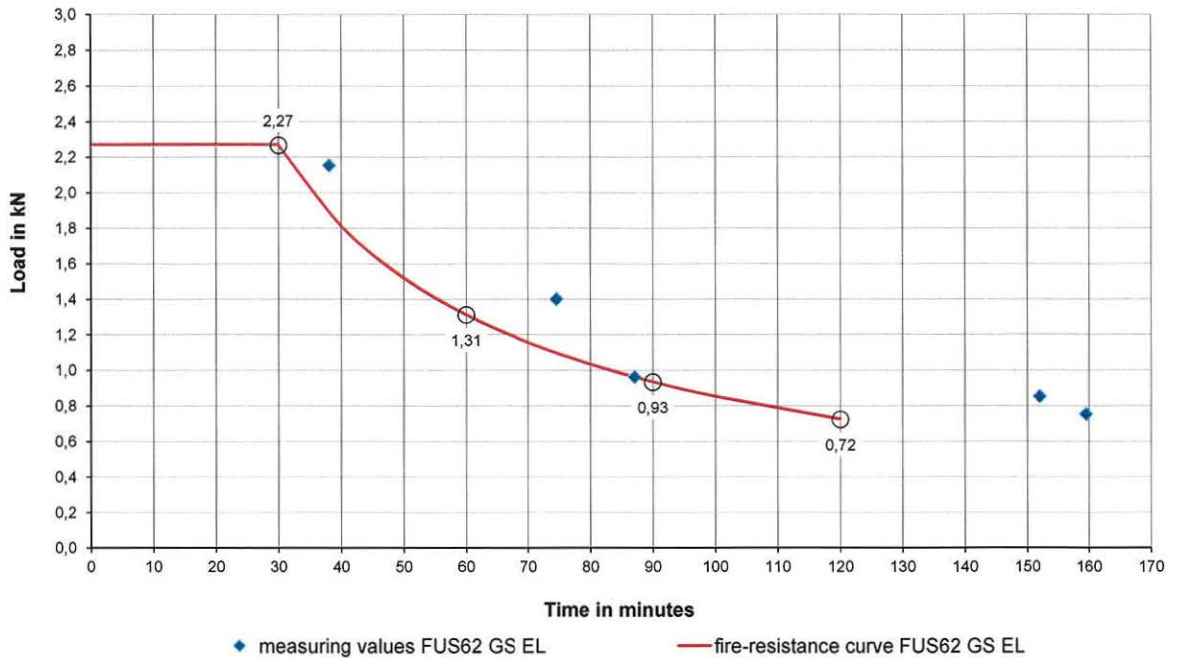

**Load-deformation curve for the combination FUS 62/2.5 – GS – EL with a static span of 1,000 mm after exposure to fire for 30 minutes**

During the test with this construction there was a sudden strong increase in the deformation. This led to a failure of the deformation measuring device. Accordingly, there are no test results to plot a load-deformation curve. However, all of the tested constructions displayed deformations greater than 50 mm irrespective of the load after 30 minutes exposure to fire.

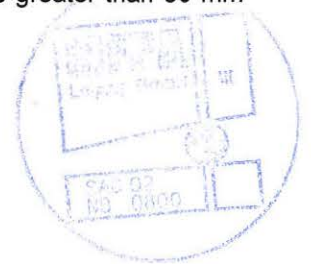

**Fire-resistance period for the combination FUS 62/2.5 – GS – ML with a static span of 1,000 mm**

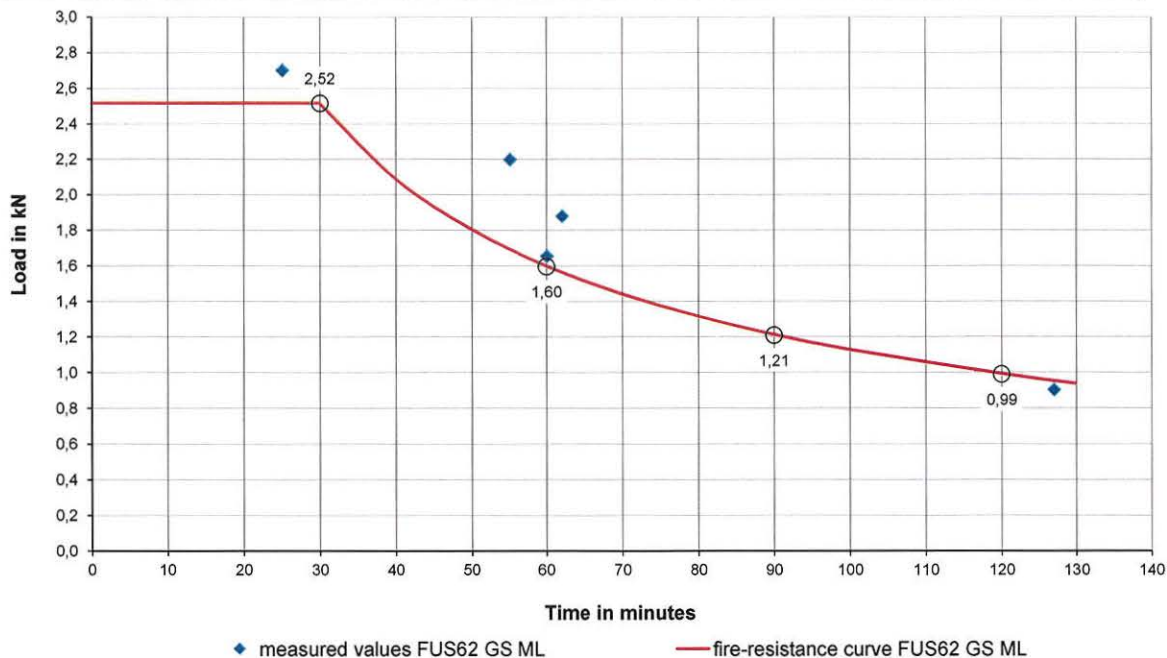

**Load-deformation curve for the combination FUS 62/2.5 – GS – ML with a static span of 1,000 mm after exposure to fire for 30 minutes**

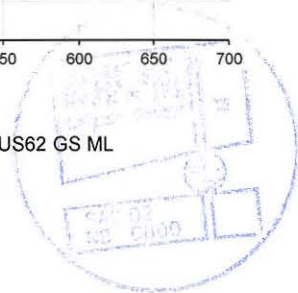
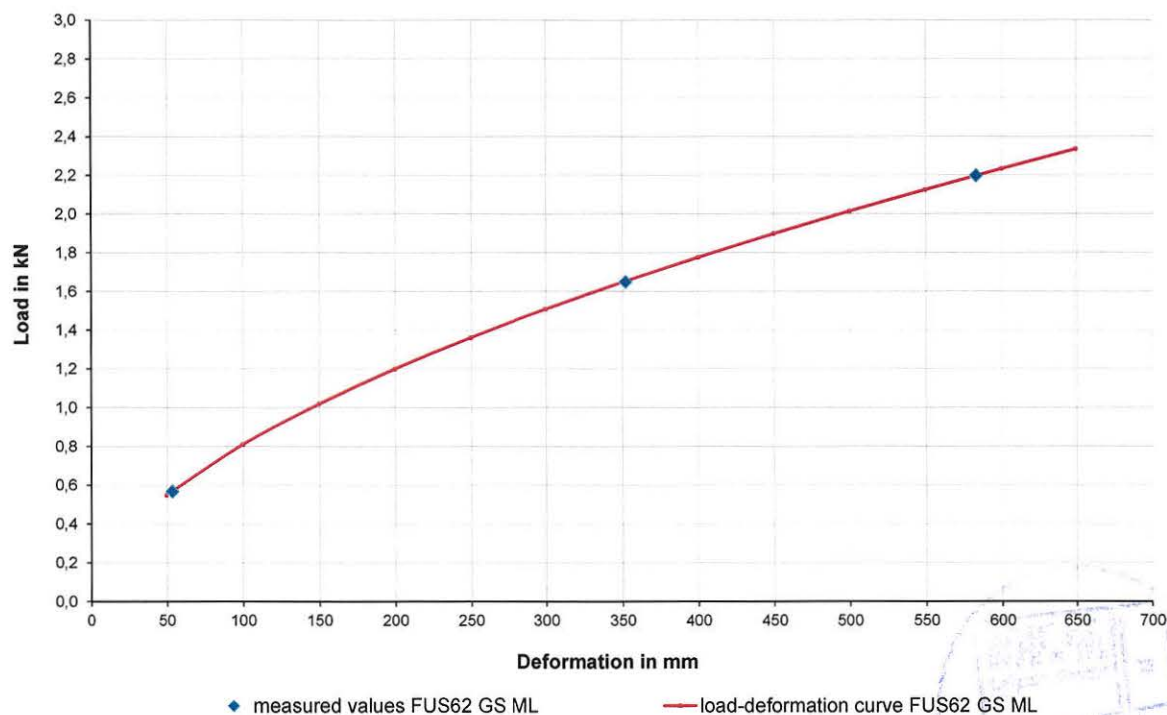

**Fire-resistance period for the combination FUS 62/2.5 – GS GL with a static span of 1,250 mm**

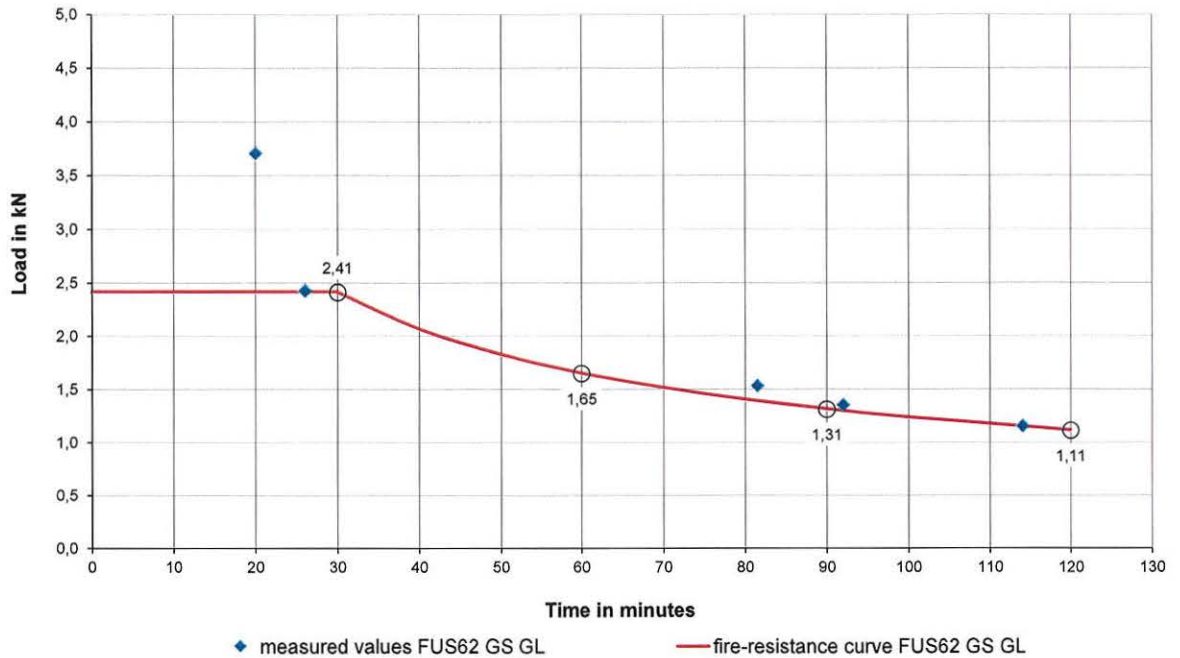

**Load-deformation curve for the combination FUS 62/2.5 – GS – GL with a static span of 1,250 mm after exposure to fire for 30 minutes**

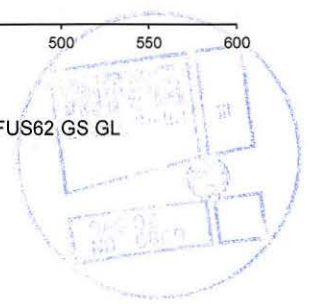
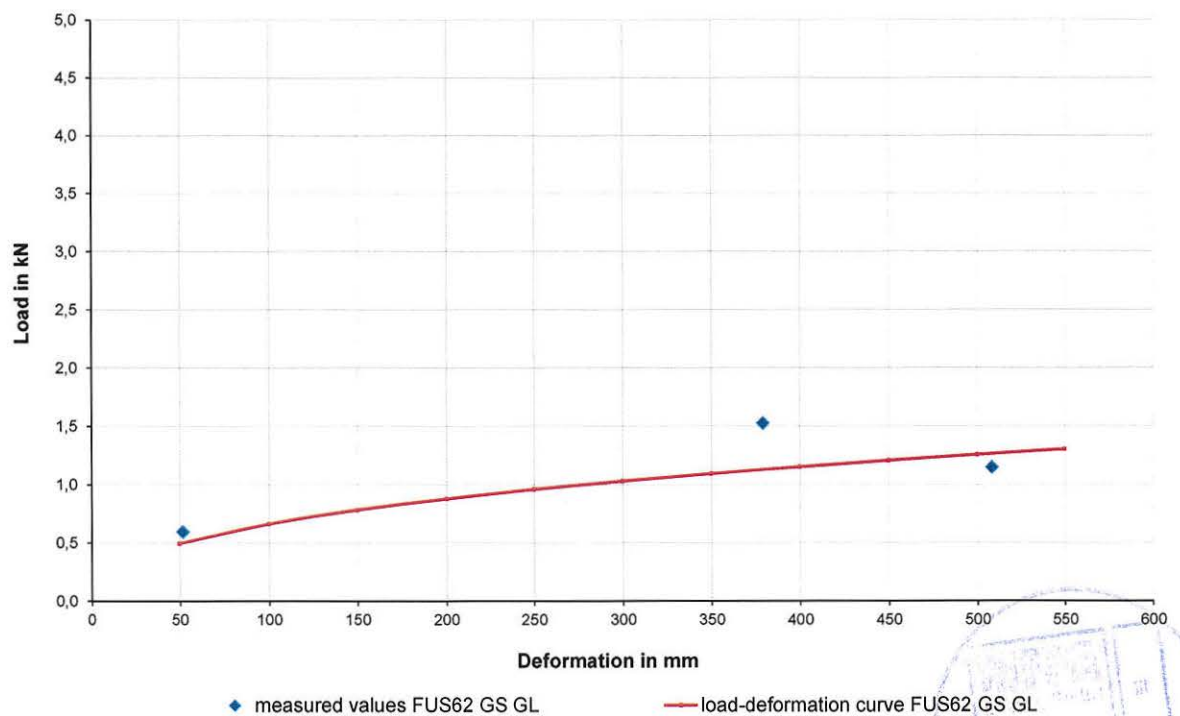



**Fire-resistance period for the combination FUS 62/2.5 – FUS 41/2.5 – EL with a static span of 1,000 mm**

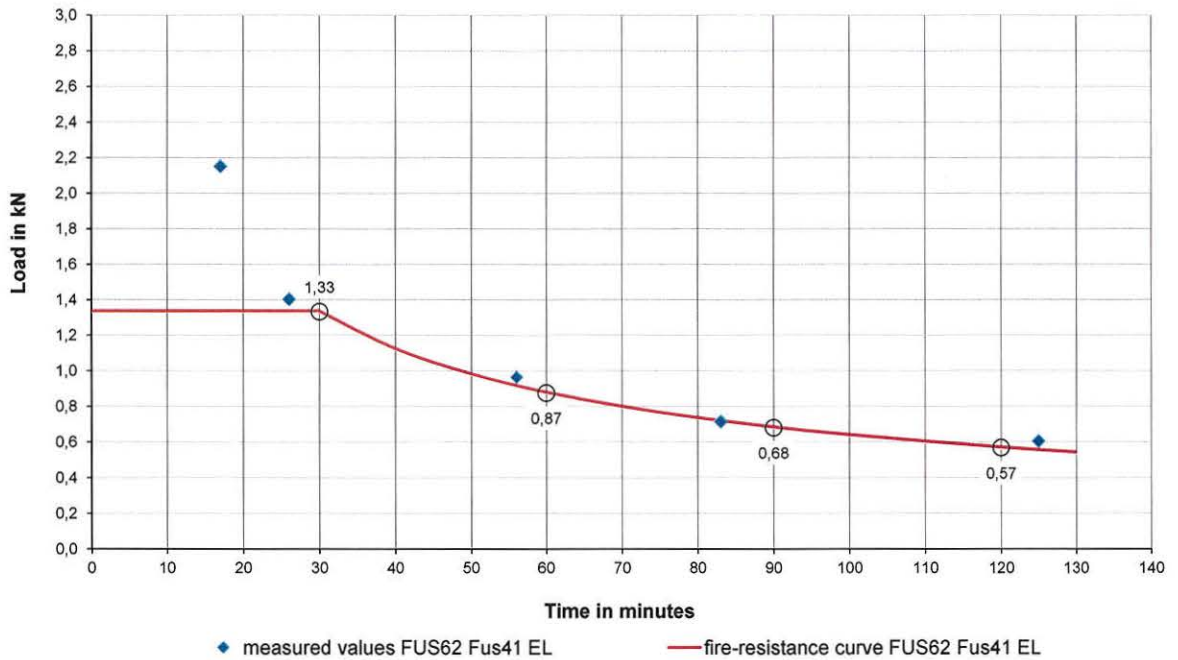

**Load-deformation curve for the combination FUS 62/2.5 – FUS 41/2.5 – EL with a static span of 1,000 mm after exposure to fire for 30 minutes**

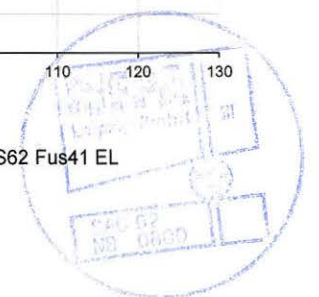
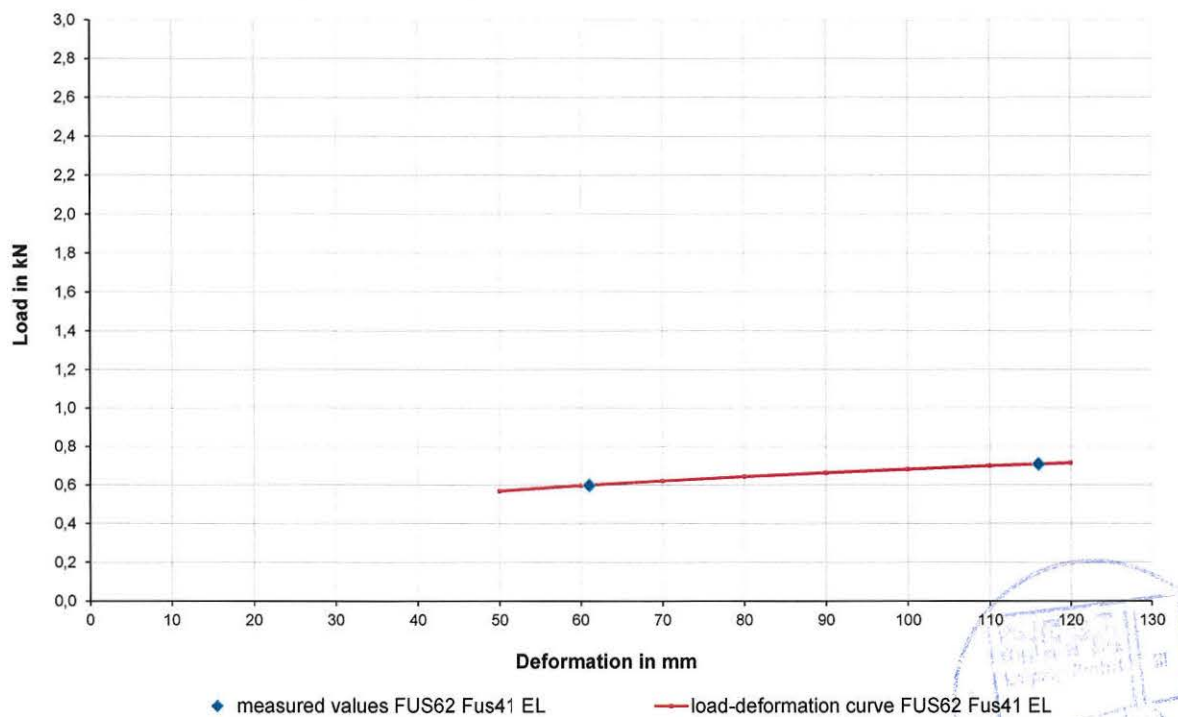

**Fire-resistance period for the combination FUS 62/2.5 – FUS 41/2.5 – ML with a static span of 1,000 mm**

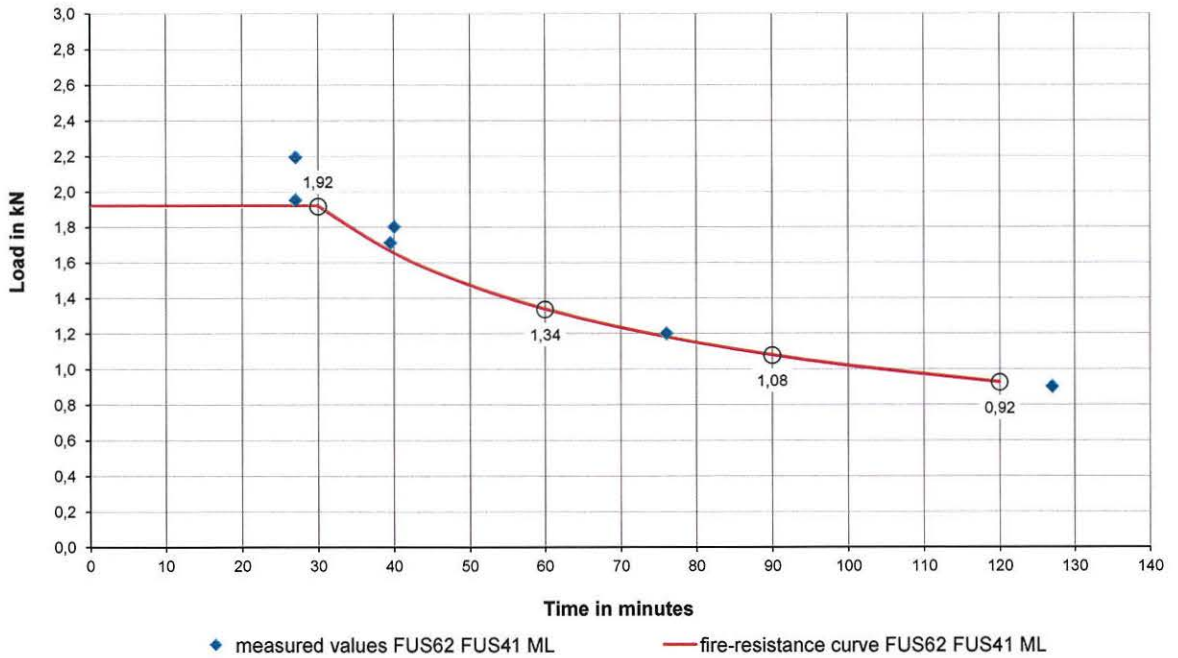

**Load-deformation curve for the combination FUS 62/2.5 – FUS 41/2.5 – ML with a static span of 1,000 mm after exposure to fire for 30 minutes**

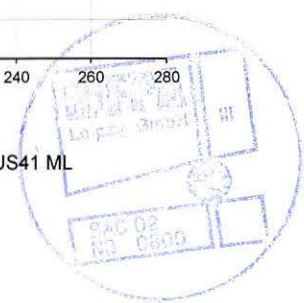
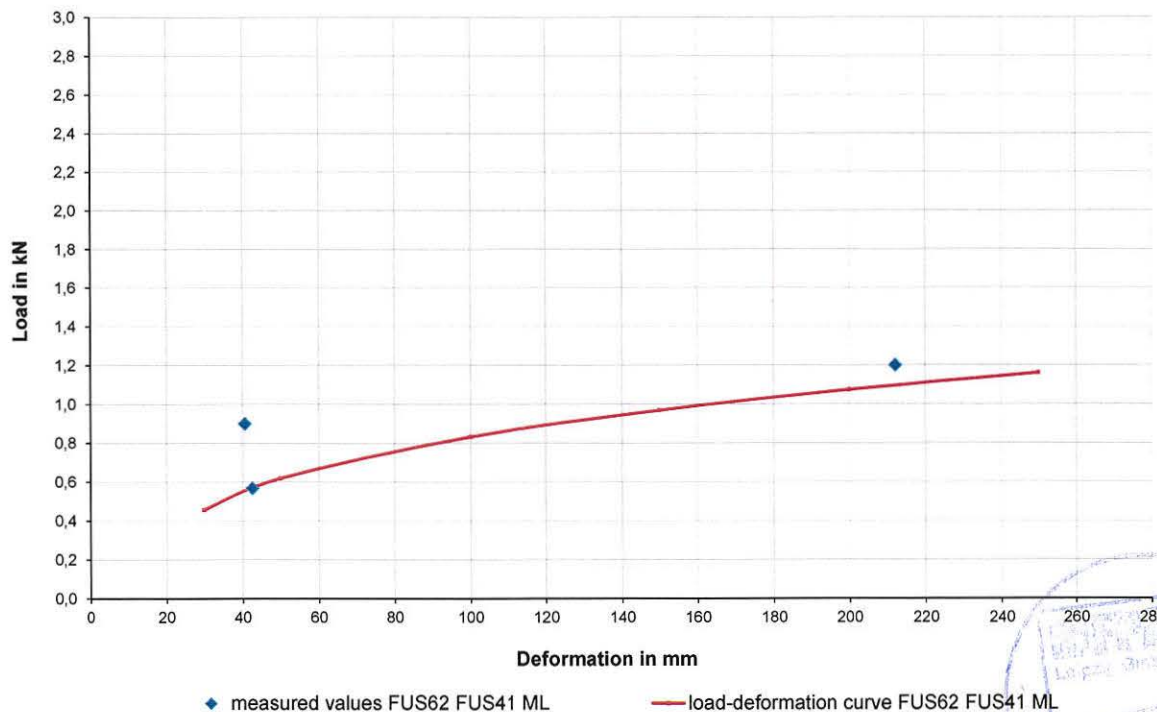

**Fire-resistance period for the combination FCA 62 – GS – ML with a static span of 960 mm**

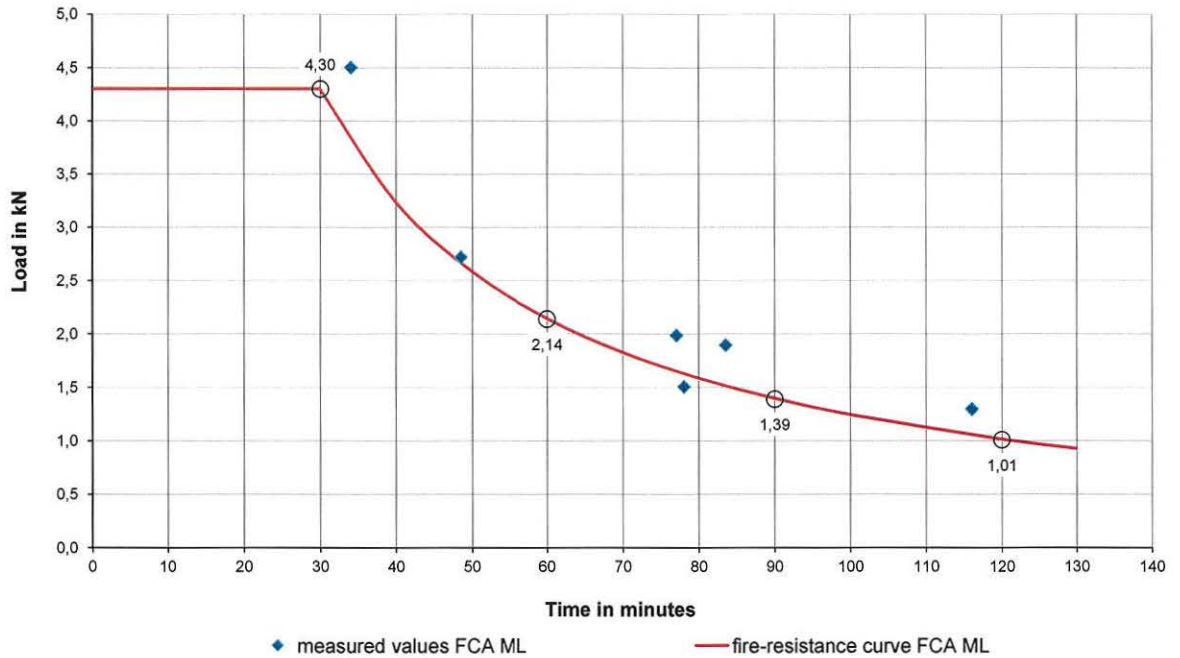

**Load-deformation curve for the combination FCA 62 – GS – ML with a static span of 960 mm after exposure to fire for 30 minutes**

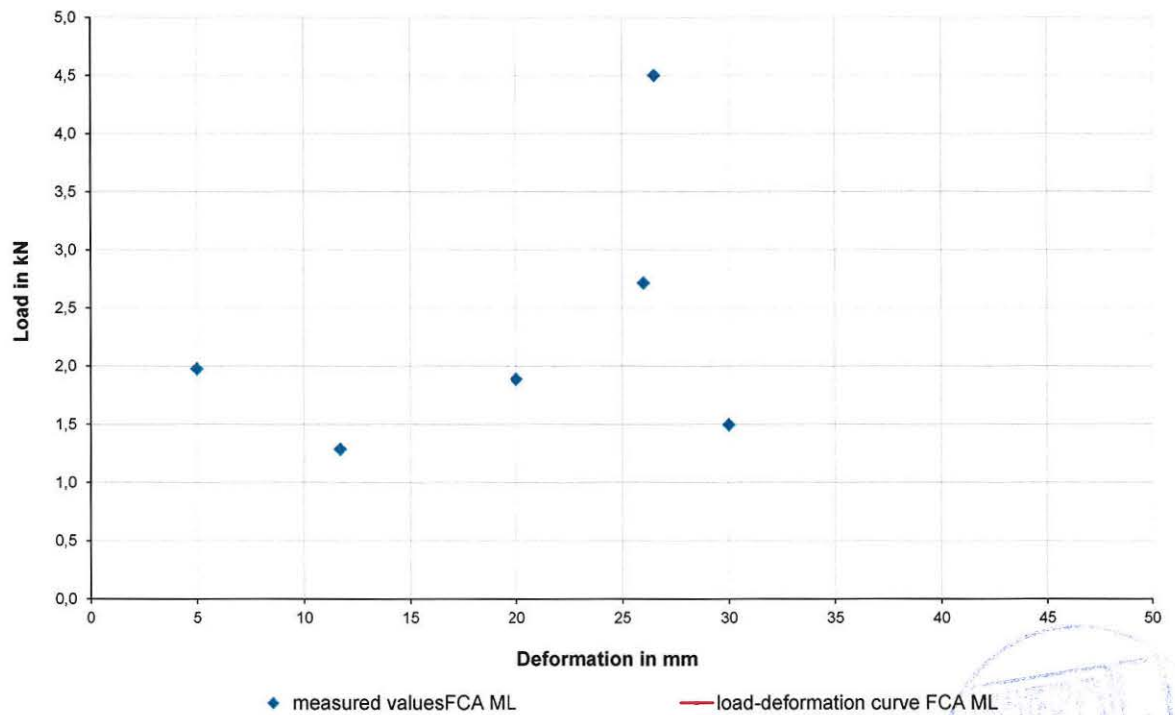

The test results show no clear load-deformation curve. However, even with a maximum load of 4.30 kN and exposure to fire for 30 minutes, no deformations greater than 50 mm are to be expected.

