

DECLARATION OF PERFORMANCE

DoP 0227

for fischer concrete screw ULTRACUT FBS II (Mechanical fastener for use in concrete)

EN

1. <u>Unique identification code of the product-type:</u>	DoP 0227		
2. <u>Intended use/es:</u>	Post-installed fastening in cracked or uncracked concrete.		
3. <u>Manufacturer:</u>	See appendix, especially annexes B1- B6 fischerwerke GmbH & Co. KG, Klaus-Fischer-Str. 1, 72178 Waldachtal, Germany		
4. <u>Authorised representative:</u>	-		
5. <u>System/s of AVCP:</u>	1		
6. <u>European Assessment Document:</u>	EAD 330232-01-0601, (Edition 12/ 2019)		
European Technical Assessment:	ETA-15/0352; 2020-10-05		
Technical Assessment Body:	DIBt- Deutsches Institut für Bautechnik		
Notified body/ies:	1343 MPA Darmstadt / 2873 TU Darmstadt		
7. <u>Declared performance/s:</u>	Mechanical resistance and stability (BWR 1)		
Characteristic resistance to tension load (static and quasi-static loading):	Resistance to steel failure:	Annexes C1, C2	$E_s = 210\,000\text{ MPa}$
	Resistance to pull- out failure:	Annexes C1, C2	
	Resistance to concrete cone failure:	Annexes C1, C2	
	Robustness:	Annexes C1, C2	
	Minimum edge distance and spacing:	Annex B4	
	Edge distance to prevent splitting under load:	Annex C1, C2	
Characteristic resistance to shear load (static and quasi-static loading), Method A:	Resistance to steel failure (shear load):	Annexes C1, C2	
	Resistance to pry-out failure:	Annexes C1, C2	
Characteristic resistance and displacements for seismic performance categories C1 and C2:	Resistance to tension load, displacements, category C1:	Annex C3	
	Resistance to tension load, displacements, category C2:	Annexes C4, C7	
	Resistance to shear load, displacements, category C1:	Annex C3	
	Resistance to shear load, displacements, category C2:	Annexes C4, C7	
	Factor for annular gap:	Annex C3, C4	
Characteristic Resistance for simplified design:	Method B:	NPD	
	Method C:	NPD	
Displacements and durability:	Displacements under static and quasi-static loading:	Annex C7	
	Durability:	Annexes A4, B1	
Safety in case of fire (BWR 2)			
Reaction to fire:	Class (A1)		
Resistance to fire:	Fire resistance to steel failure (tension load):	Annexes C5, C6	
	Fire resistance to pull-out failure (tension load):	Annexes C5, C6	
	Fire resistance to steel failure (shear load):	Annexes C5, C6	



8. Appropriate Technical Documentation and/or Specific –
Technical Documentation:

The performance of the product identified above is in conformity with the set of declared performance/s. This declaration of performance is issued, in accordance with Regulation (EU) No 305/2011, under the sole responsibility of the manufacturer identified above.

Signed for and on behalf of the manufacturer by:

Thilo Pregartner, Dr.-Ing.
Tumlingen, 2020-10-19

Peter Schillinger, Dipl.-Ing.

This DoP has been prepared in different languages. In case there is a dispute on the interpretation the English version shall always prevail.

The Appendix includes voluntary and complementary information in English language exceeding the (language-neutrally specified) legal requirements.

Specific Part

1 Technical description of the product

The fischer concrete screw ULTRACUT FBS II is an anchor of sizes 6, 8, 10, 12 and 14 mm made of hardened carbon steel. The anchor is screwed into a predrilled cylindrical drill hole. The special thread of the anchor cuts an internal thread into the member while setting. The anchorage is characterised by mechanical interlock in the special thread.

The product description is given in Annex A.

2 Specification of the intended use in accordance with the applicable European Assessment Document

The performances given in Section 3 are only valid if the anchor is used in compliance with the specifications and conditions given in Annex B.

The verifications and assessment methods on which this European Technical Assessment is based lead to the assumption of a working life of the anchor of at least 50 years. The indications given on the working life cannot be interpreted as a guarantee given by the producer, but are to be regarded only as a means for choosing the right products in relation to the expected economically reasonable working life of the works.

3 Performance of the product and references to the methods used for its assessment

3.1 Mechanical resistance and stability (BWR 1)

Essential characteristic	Performance
Characteristic resistance to tension load (static and quasi-static loading)	See Annex B 4, Annex C 1 and C 2
Characteristic resistance to shear load (static and quasi-static loading)	See Annex C 1 and C 2
Displacements and Durability	See Annex C 7 and Annex B 1
Characteristic resistance and displacements for seismic performance categories C1 and C2	See Annex C 3, C 4 and C 7

3.2 Safety in case of fire (BWR 2)

Essential characteristic	Performance
Reaction to fire	Class A1
Resistance to fire	See Annex C 5 and C 6

4 Assessment and verification of constancy of performance (AVCP) system applied, with reference to its legal base

In accordance with European Assessment Document EAD No. 330232-01-0601 the applicable European legal act is: [96/582/EC].

The system to be applied is: 1

Product in the installed condition

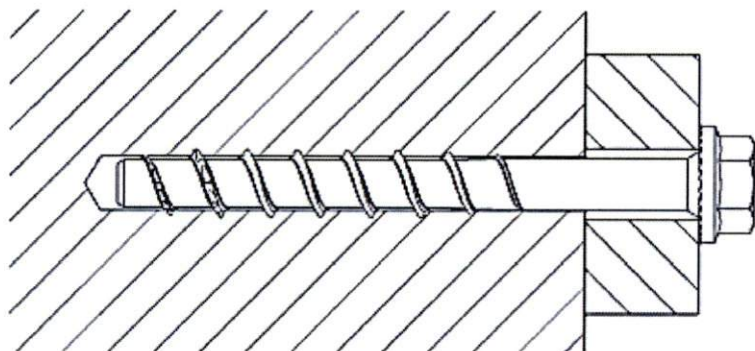

FBS II US
(6 – 14)

FBS II US CP
(8 – 14)

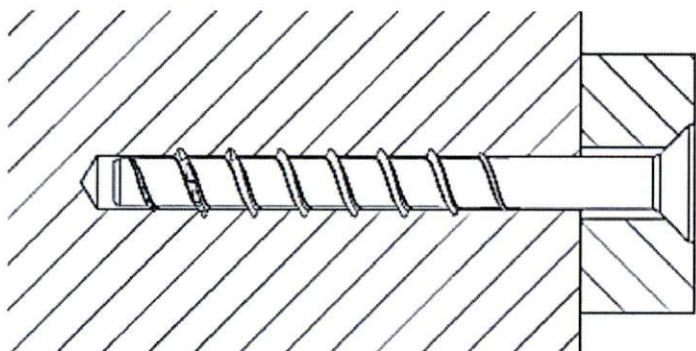

FBS II SK
(6 – 10)

FBS II SK CP
(8 – 10)

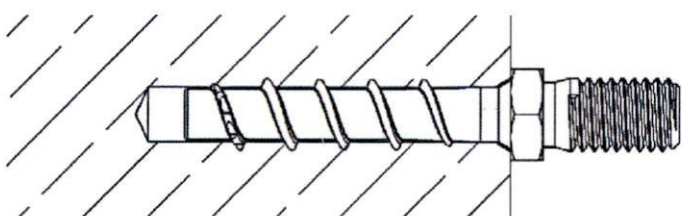











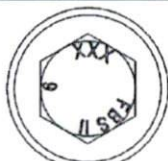
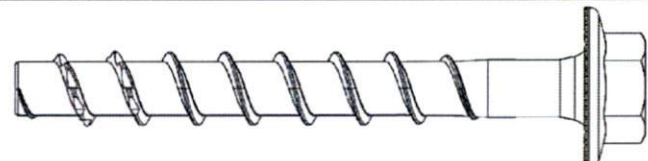

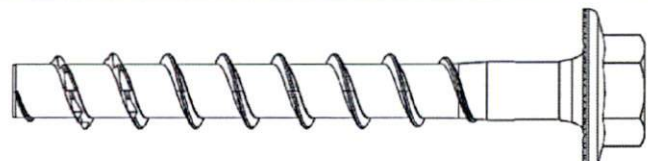
FBS II 6 M8

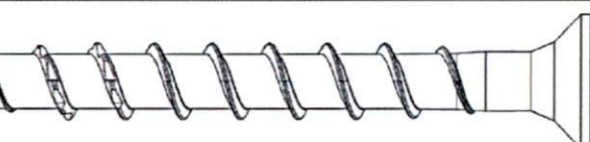
(Fig. not to scale)

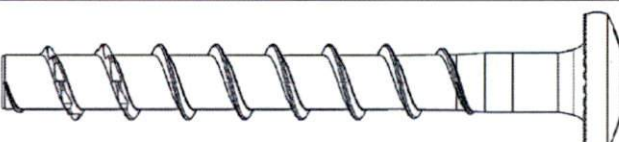
fischer concrete screw ULTRACUT FBS II		Annex A 1 Appendix 3/ 19
Product description Product in the installed condition		

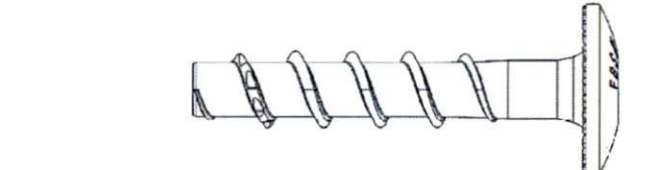
Table A2.1: Screw types FBS II 6

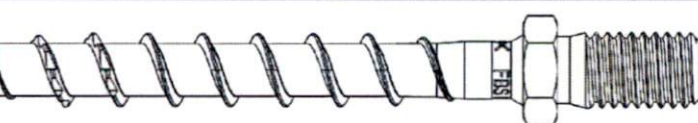
FBS II 6

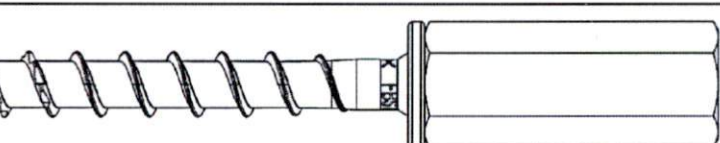
<p>Hexagon head with formed washer (US)</p>		
<p>Hexagon head with formed washer and TX-drive (US TX)</p>		
<p>Countersunk Head (SK)</p>		
<p>Pan head (P)</p>		
<p>Large Pan head (LP)</p>		
<p>Hexagon head and connection thread M8 or M10 (M)</p>		
<p>Hexagon connecting nut with metric internal thread (I)</p>		

(Fig. not to scale)

fischer concrete screw ULTRACUT FBS II







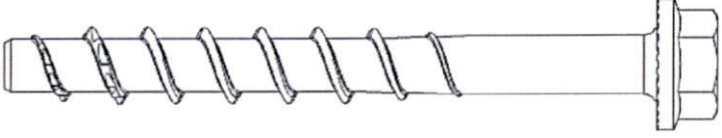

Product description
Screw types FBS II 6

Annex A 2

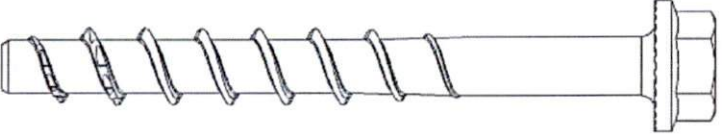
Appendix 4/ 19

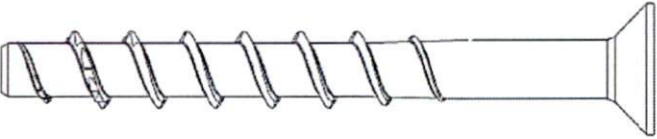
Table A3.1: Screw types FBS II 8 – 14

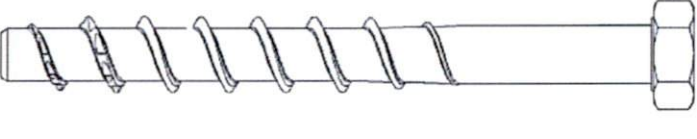
FBS II 8 - 14

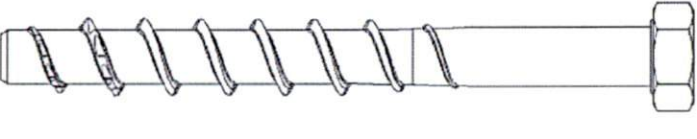
<p>Hexagon head with formed washer (US)</p>		
<p>Hexagon head with formed washer and TX-drive (US TX)</p>		
<p>Countersunk Head (SK)</p>		
<p>Hexagon head (S)</p>		
<p>Hexagon head with TX-drive (S TX)</p>		

(Fig. not to scale)

fischer concrete screw ULTRACUT FBS II

Product description
Screw types FBS II 8 to 14

Annex A 3

Appendix 5/ 19

Table A4.1: Geometry and material

Screw types / size		All head shapes					
		6	8	10	12	14	
Thread outer diameter	d_a	[mm]	7,75	10,3	12,5	14,5	16,6
Core diameter	d_k		5,65	7,4	9,4	11,3	13,3
Shaft diameter	d_s		6,0	8,0	9,9	11,7	13,7
Material		[-]	Hardened carbon steel; $A_5 \geq 8\%$				
Coating FBS II			galvanized				
Coating FBS II CP			-	Multilayer coating			

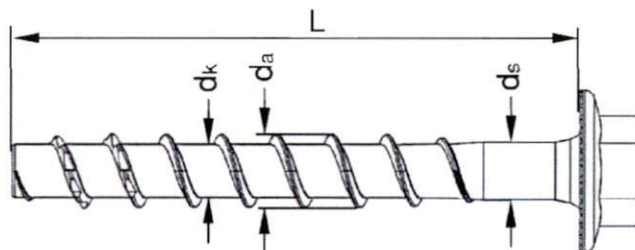

Head marking US, US TX, S, S TX, SK, P, LP

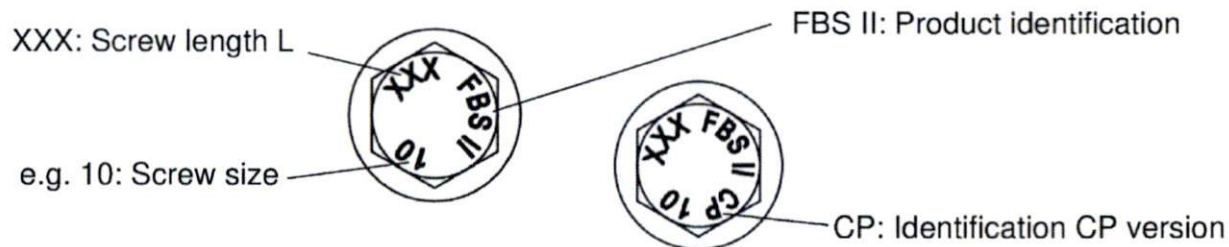

Marking at M8, M10, I

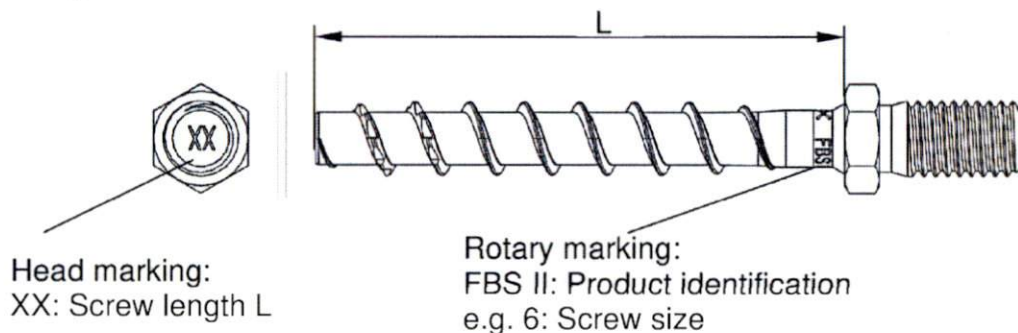

(Fig. not to scale)

fischer concrete screw ULTRACUT FBS II

Product description
Geometry and marking

Annex A 4

Appendix 6/ 19

Specification of intended use

Table B1.1: Anchorages subject to

Size	6		8		10			12			14		
Nominal embedment depth [mm]	40-55	50	65	55	65	85	60	75	100	65	85	115	
Static and quasi-static loads in cracked and uncracked concrete	✓												
Fire exposure													
Seismic performance category C1	✓		✓			✓			✓			✓	
Seismic performance category C2													

Base materials:

- Compacted reinforced or unreinforced normal weight concrete without fibres (cracked and uncracked) according to EN 206:2013+A1:2016
- Strength classes C20/25 to C50/60 according to EN 206:2013+A1:2016

Use conditions (Environmental conditions):

- Structures subjected to dry internal conditions

Design:

- Anchorages are to be designed under the responsibility of an engineer experienced in anchorages and concrete work.
- Verifiable calculation notes and drawings are to be prepared taking account of the loads to be anchored. The position of the screw is indicated on the design drawings (e.g. position of the screw relative to reinforcement or to supports, etc.).
- Design of fastenings according to EN 1992-4: 2018 and EOTA Technical Report TR 055.

Installation:

- Hammer drilling or hollow drilling:
All sizes and embedment depths.
- Alternative diamond drilling: All sizes and embedment depths from diameter 8.
- Screw installation carried out by appropriately qualified personnel and under the supervision of the person responsible for technical matters on site.
- In case of aborted hole: New hole must be drilled at a minimum distance of twice the depth of the aborted hole or closer, if the hole is filled with a high strength mortar and only if the hole is not in the direction of the oblique tensile or shear load.
- Adjustability according to Annex B4 for: All sizes and embedment depths.
- Cleaning of drill hole is not necessary when using a hollow drill with functional suction or:
 - If drilling vertically upwards
 - If drilling vertical downwards and the drill hole depth has been increased. It is recommended to increase the drill depth with additional $3 d_0$
- After correct installation further turning of the screw shall not be possible.
- The head of the screw must be fully engaged on the fixture and show no signs of damage.
- For seismic performance category C2 applications: The gap between screw shaft and fixture must be filled with mortar; mortar compressive strength $\geq 50 \text{ N/mm}^2$ (e. g. FIS V, FIS HB, FIS SB or FIS EM Plus).

fischer concrete screw ULTRACUT FBS II

Intended use
Specification

Annex B 1

Appendix 7/ 19

Table B2.1: Installation parameters FBS II 6 - drilling bore hole and setting tools

FBS II 6			All head shapes
Nominal embedment depth	h_{nom}	[mm]	$40 \leq h_{nom} \leq 55$
Nominal drill hole diameter	d_0		6
Cutting diameter of drill bits	$d_{cut} \leq$		6,4
Clearance hole diameter	$d_f \leq$		8
Drill hole depth			$h_{nom} + 10^{1)}$
Drill hole depth (with adjustable setting)	$h_1 \geq$		$h_{nom} + 20$
Torque impact screw driver	$T_{imp,max}$	[Nm]	450
Maximum installation torque with metrical screws or hexagon nuts on head shapes M and I	T_{max}	[Nm]	10

¹⁾ Value can be reduced to $h_{nom} + 5$ for installation vertically upwards

Table B2.2: Installation parameters FBS II 6 – drive and fixture

FBS II 6			US	US TX	SK	P	LP	M8	M10	I
Wrench size	SW	[mm]	10 / 13		-			10	13	-
TX size	TX	[-]	-	30						
Head diameter	d_h	[mm]	17		13,5	14,4	17,5	-		
Thickness of fixture	$t_{fix} \leq$		$L - h_{nom}$							
Length of screw	$L_{min} =$ $L_{max} =$		40							
			325					55		

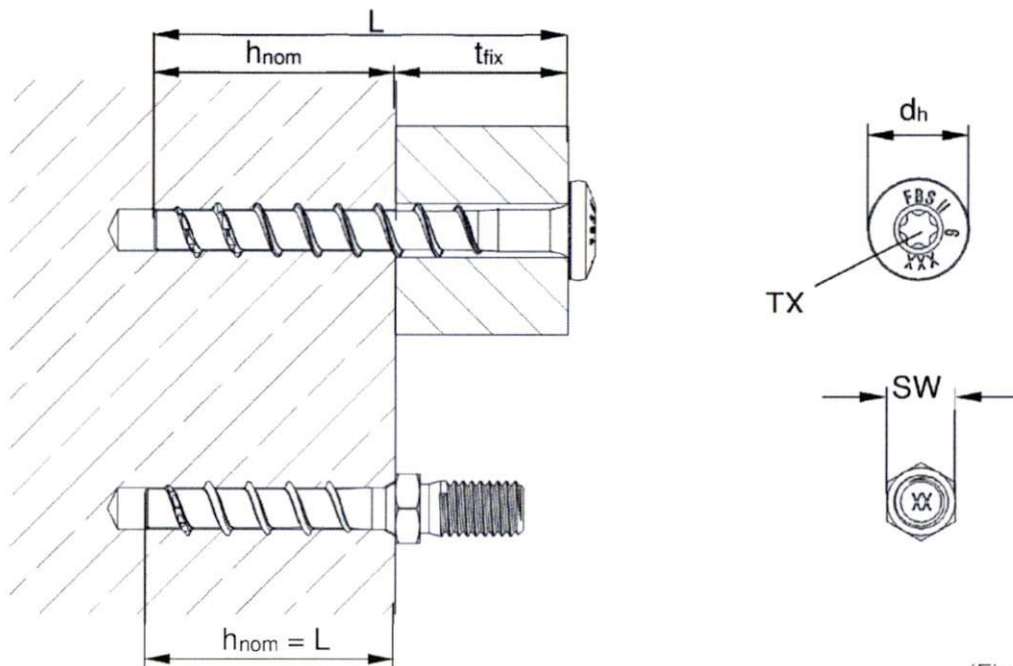

(Fig. not to scale)

fischer concrete screw ULTRACUT FBS II

Intended use
Installation parameters FBS II 6

Annex B 2

Appendix 8/ 19

Table B3.1: Installation parameters FBS II 8 - 14

Size		FBS II										
		8		10			12			14		
Nominal embedment depth	h_{nom}	50	65	55	65	85	60	75	100	65	85	115
Nominal drill hole diameter	d_0	8		10			12			14		
Cutting diameter of drill bits		8,45		10,45			12,50			14,50		
Cutting diameter of diamond driller	$d_{cut} \leq$	8,10		10,30			12,30			14,30		
Clearance hole diameter	d_r	10,6 – 12,0		12,8 – 14,0			14,8 – 16,0			16,9 – 18,0		
Wrench size (US,S)	SW	13		15			17			21		
Tx size	Tx	[-]		40			50					
Head diameter	d_h	18		21								
Countersunk diameter in fixture	d_c	20		23								
Drill hole depth		60	75	65	75	95	70	85	110	80	100	130
Drill hole depth (with adjustable setting)	$h_1 \geq$	70	85	75	85	105	80	95	120	90	110	140
Thickness of fixture	$t_{fix} \leq$	L - h_{nom}										
Length of screw	$L_{min} =$	50	65	55	65	85	60	75	100	65	85	115
	$L_{max} =$	400	415	405	415	435	410	425	450	415	435	465
Torque impact screw driver	$T_{imp,max}$	[Nm]		600			650					

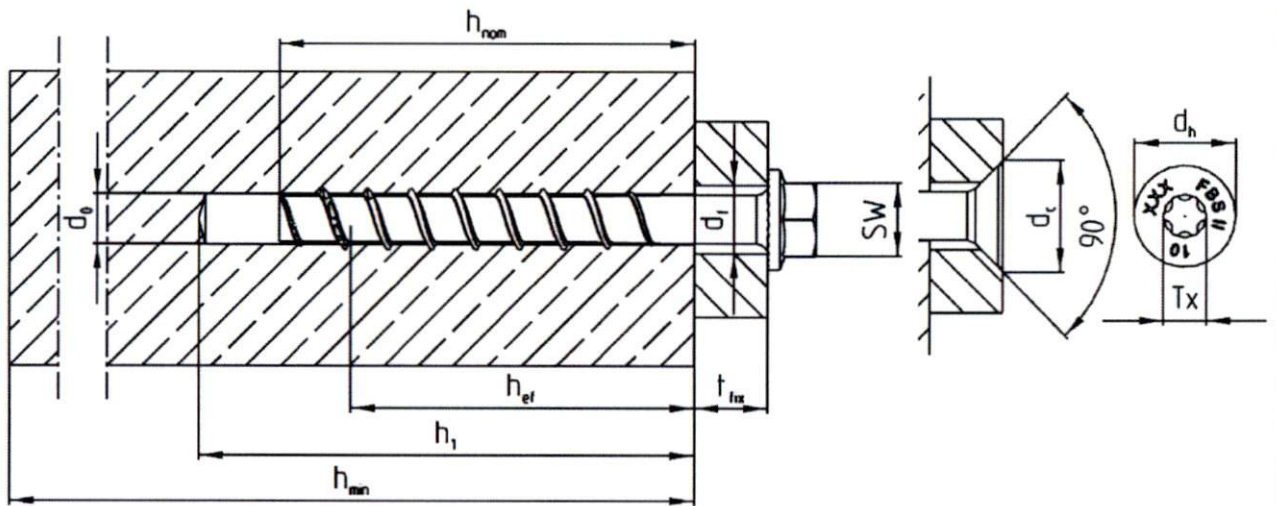

(Fig. not to scale)

fischer concrete screw ULTRACUT FBS II

Intended use
Installation parameters FBS II 8 - 14

Annex B 3

Appendix 9/ 19

Adjustment

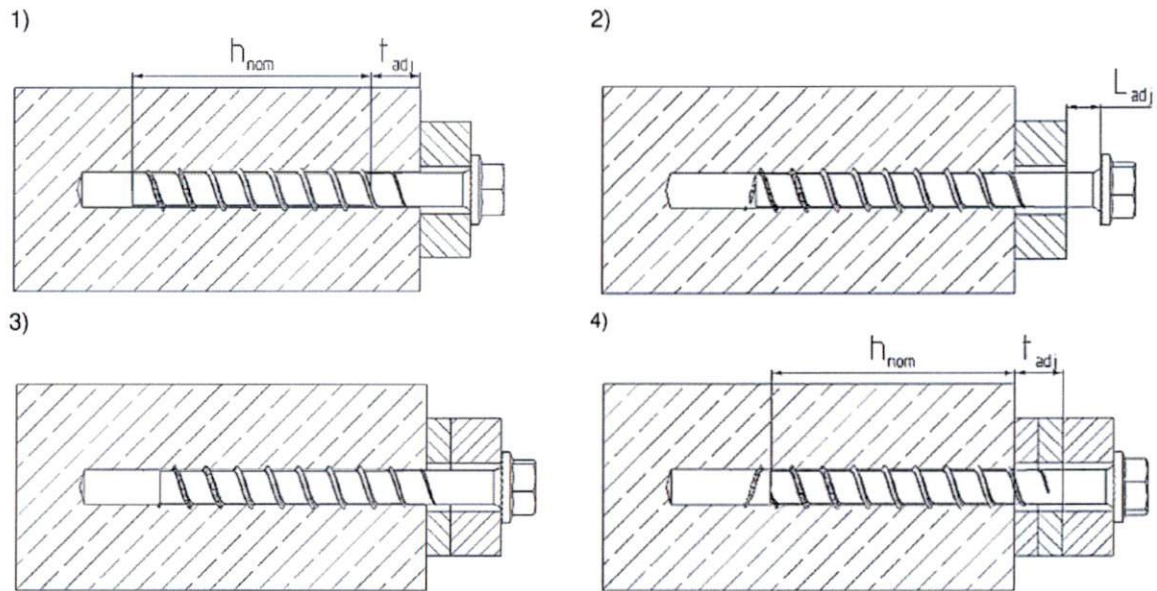

It is permissible to untighten the screw up to two times for adjustment purposes. Therefore, the screw may be untightened to a maximum of $L_{adj} = 20$ mm to the surface of the initial fixture.

The total permissible thickness of shims added during the adjustment process is $t_{adj} = 10$ mm

(Fig. not to scale)

Table B4.1: Minimum thickness of concrete members, minimum spacing and edge distance

Size		FBS II												
		6		8		10			12		14			
Nominal embedment depth	h_{nom}	[mm]	40 to 55	50	65	55	65	85	60	75	100	65	85	115
Minimum thickness of concrete member	h_{min}		max.(80; $h_1^{1)} + 30$)	100	120	100	120	140	110	130	150	120	140	180
Minimum spacing	s_{min}		35	35	40			50		60				
Minimum edge distance	c_{min}		35	35	40			50		60				

¹⁾ Drill hole depth according to table B2.1

fischer concrete screw ULTRACUT FBS II

Intended use

Adjustment

Minimum thickness of members, minimum spacing and edge distance

Annex B 4

Appendix 10/ 19

Installation instruction part 1

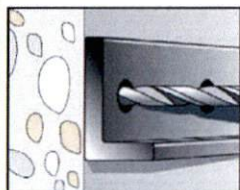

Step 1: Creation of the drill hole:

Drill the hole using hammer drill, hollow drill or diamond core drill (from diameter 8).

Drill hole diameter d_0 and drill hole depth h_1 according to table B2.1 and B3.1

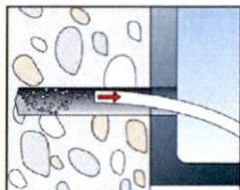

Step 2: Cleaning of the drill hole - horizontal:

Clean the drill hole. This step can be omitted in the preparation of the hole by using a hollow drill bit or diamond core drill. (recommendation: use the fischer FHD hollow drill bit)

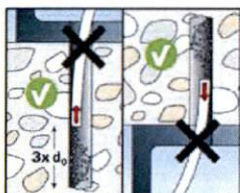

Step 2: Cleaning of the drill hole - vertical:

Cleaning of the drill hole can be omitted, if drilling vertically upwards or if drilling vertically downwards and the hole depth has been increased. It is recommended to increase the drill hole depth by an additional $3 \times d_0$ when drilling vertically downwards.

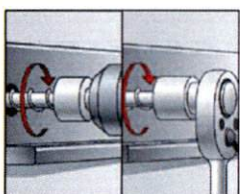

Step 3: Installation:

Installation with any torque impact screw driver up to the maximum mentioned torque moment ($T_{imp,max}$ according to table B2.1 and B3.1).

(recommendation: use the fischer FSS 18V 400BL)

Alternatively, all other tools without an indicated torque moment are allowed (e.g. ratchet spanner). The indicated torque moments $T_{imp,max}$ for impact screw driver are not decisive for manual installation.

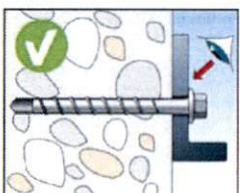

Step 4: Checking of the correct installation:

After installation a further turning of the screw must not be possible. The head of the screw must be in contact with the fixture and is not damaged

fischer concrete screw ULTRACUT FBS II

Intended use
Installation instruction

Annex B 5

Appendix 11/ 19

Installation instruction part 2

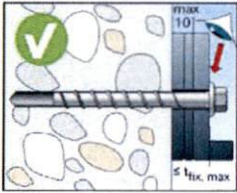
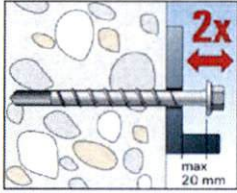
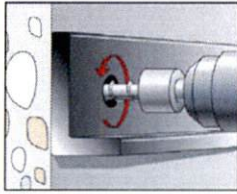

Adjustment

Optional:

It is permissible to adjust the screw twice. Therefore, the screw may be untightened to a maximum of $L_{adj} = 20$ mm off the surface of the initial fixture. The total permissible thickness of shims added during the adjustment process is $t_{adj} = 10$ mm.

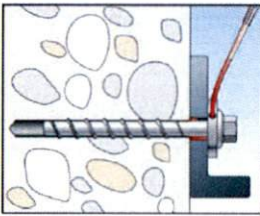

Filling of the annular gap

For seismic performance category C2 applications: The gap between screw shaft and fixture must be filled with mortar; mortar compressive strength ≥ 50 N/mm² (e. g. FIS V, FIS HB, FIS SB or FIS EM Plus). As an aid for filling the gap, the filling disc FFD is recommended.

fischer concrete screw ULTRACUT FBS II

Intended use
Installation instruction

Annex B 6

Appendix 12/ 19

Table C1.1: Characteristic values for static and quasi-static action with FBS II 6

FBS II 6							
Nominal embedment depth	h_{nom}	[mm]	40	45	50	55	
Steel failure for tension load and shear load							
Characteristic resistance	$N_{Rk,s}$	[kN]	21				
Partial factor	$\gamma_{Ms,N}$	[-]	1,4				
Characteristic resistance	$V^0_{Rk,s}$	[kN]	9,0			13,3	
Partial factor	$\gamma_{Ms,V}$	[-]	1,5				
Factor for ductility	k_7		1,0				
Characteristic bending resistance	$M^0_{Rk,s}$	[Nm]	17,1				
Pullout failure							
Characteristic resistance in concrete C20/25	uncracked	$N_{Rk,p}$	[kN]	8,0	10,0	12,0	13,5
	cracked	$N_{Rk,p}$		2,5	3,5	4,0	5,0
Increasing factors concrete	C25/30	ψ_c	[-]	1,12			
	C30/37			1,22			
	C35/45			1,32			
	C40/50			1,41			
	C45/55			1,50			
	C50/60			1,58			
Installation factor	γ_{inst}	[-]	1,0				
Concrete cone failure and splitting failure; concrete pryout failure							
Effective embedment depth	h_{ef}	[mm]	32	36	40	44	
Factor for uncracked concrete	$k_{ucr,N}$	[-]	11,0				
Factor for cracked concrete	$k_{cr,N}$		7,7				
Characteristic edge distance	$c_{cr,N}$	[mm]	1,5 h_{ef}				
Characteristic spacing	$s_{cr,N}$		3 h_{ef}				
Charakt. resistance for splitting	$N^0_{Rk,sp}$	[kN]	$\min(N^0_{Rk,c}{}^1; N_{Rk,p})$				
Charact. edge distance for splitting	$c_{cr,sp}$	[mm]	1,5 h_{ef}				
Charakt. spacing for splitting	$s_{cr,sp}$		3 h_{ef}				
Factor for pryout failure	k_B	[-]	2,0				
Installation factor	γ_{inst}		1,0				
Concrete edge failure							
Effective length in concrete	l_f	[mm]	40	45	50	55	
Nominal diameter of screw	d_{nom}		6				
Adjustment							
Maximum thickness of shims	t_{adj}	[mm]	10				
Max. number of adjustments	n_a	[-]	2				
1) $N^0_{Rk,c}$ according EN 1992-4:2018							
fischer concrete screw ULTRACUT FBS II						Annex C 1 Appendix 13/ 19	
Performances Characteristic values for static and quasi-static action with FBS II 6							

Table C2.1: Characteristic values for static and quasi-static action with FBS II 8 - 14

Size			FBS II										
			8		10			12			14		
Nominal embedment depth	h_{nom}	[mm]	50	65	55	65	85	60	75	100	65	85	115
Steel failure for tension load and shear load													
Characteristic resistance	$N_{Rk,s}$	[kN]	35		55			76			103		
Partial factor	$\gamma_{Ms,N}$	[-]	1,4										
Characteristic resistance	$V^0_{Rk,s}$	[kN]	13,1	19,0	29,4		34,9	31,9		42,7	46,5		61,7
Partial factor	$\gamma_{Ms,V}$	[-]	1,5										
Factor for ductility	k_7		1,0										
Characteristic bending resistance	$M^0_{Rk,s}$	[Nm]	51		95			165			269		
Pullout failure													
Characteristic resistance in concrete C20/25	uncracked	$N_{Rk,p}$	[kN]		$\geq N^0_{Rk,c^{1)}$								
	cracked	$N_{Rk,p}$	[kN]	6	12	9	12	$\geq N^0_{Rk,c^{1)}$					
Increasing factors concrete	C25/30	ψ/c	[-]	1,12									
	C30/37			1,22									
	C35/45			1,32									
	C40/50			1,41									
	C45/55			1,50									
	C50/60			1,58									
Installation factor	γ_{inst}	[-]	1,0										
Concrete cone failure and splitting failure; concrete pryout failure													
Effective embedment depth	h_{ef}	[mm]	40	52	43	51	68	47	60	81	50	67	93
Factor for uncracked concrete	$k_{ucr,N}$	[mm]	11,0										
Factor for cracked concrete	$k_{cr,N}$	[mm]	7,7										
Characteristic edge distance	$c_{cr,N}$	[mm]	1,5 h_{ef}										
Characteristic spacing	$s_{cr,N}$	[mm]	3 h_{ef}										
Charakt. resistance for splitting	$N^0_{Rk,sp}$	[kN]	$\min(N^0_{Rk,c^{1)}; N_{Rk,p})$										
Charact. edge distance for splitting	$c_{cr,sp}$	[mm]	1,5 h_{ef}										
Charakt. spacing for splitting	$s_{cr,sp}$	[mm]	3 h_{ef}										
Factor for pryout failure	k_8	[-]	1,0	2,0	1,0	2,0							
Installation factor	γ_{inst}	[-]	1,0										
Concrete edge failure													
Effective length in concrete	l_f	[mm]	50	65	55	65	85	60	75	100	65	85	115
Nominal diameter of screw	d_{nom}	[mm]	8		10			12			14		
Adjustment													
Maximum thickness of shims	t_{adj}	[mm]	10										
Max. number of adjustments	n_a	[-]	2										
1) $N^0_{Rk,c}$ according EN 1992-4:2018													
fischer concrete screw ULTRACUT FBS II											Annex C 2		
Performances Characteristic values for static and quasi-static action with FBS II 8 - 14													
Appendix 14/ 19													

Table C3.1: Characteristic values for seismic performance category C1 with FBS II 6						
FBS II 6						
Nominal embedment depth	h_{nom}	[mm]	40	45	50	55
Steel failure for tension load and shear load						
Characteristic resistance	$\frac{N_{Rk,s,C1}}{V_{Rk,s,C1}}$	[kN]	21			
			6,3		9,3	
Without filling of the annular gap ¹⁾	α_{gap}	[-]	0,5			
With filling of the annular gap ¹⁾			1,0			
Pullout failure						
Characteristic resistance in cracked concrete	$N_{Rk,p,C1}$	[kN]	2,5	3,5	4,0	5,0
Concrete cone failure						
Effective embedment depth	h_{ef}	[mm]	32	36	40	44
Characteristic edge distance	$c_{cr,N}$		1,5 h_{ef}			
Characteristic spacing	$s_{cr,N}$		3 h_{ef}			
Installation factor	γ_{inst}	[-]	1,0			
Concrete pryout failure						
Factor for pryout failure	k_8	[-]	2,0			
Concrete edge failure						
Effective length in concrete	l_f	[mm]	40	45	50	55
Nominal diameter of screw	d_{nom}		6			

Table C3.2: Characteristic values for seismic performance category C1 with FBS II 8 – 14						
Size	FBS II					
	8	10	12	14		
Nominal embedment depth	h_{nom}	[mm]	65	85	100	115
Steel failure for tension load and shear load						
Characteristic resistance	$\frac{N_{Rk,s,C1}}{V_{Rk,s,C1}}$	[kN]	35	55	76	103
			11,4	22,3	26,9	38,3
Without filling of the annular gap ¹⁾	α_{gap}	[-]	0,5			
With filling of the annular gap ¹⁾			1,0			
Pullout failure						
Characteristic resistance in cracked concrete	$N_{Rk,p,C1}$	[kN]	12	$\geq N^0_{Rk,c^{(2)}}$		
Concrete cone failure						
Effective embedment depth	h_{ef}	[mm]	52	68	81	93
Characteristic edge distance	$c_{cr,N}$		1,5 h_{ef}			
Characteristic spacing	$s_{cr,N}$		3 h_{ef}			
Installation factor	γ_{inst}	[-]	1,0			
Concrete pryout failure						
Factor for pryout failure	k_8	[-]	2,0			
Concrete edge failure						
Effective length in concrete	l_f	[mm]	65	85	100	115
Nominal diameter of screw	d_{nom}		8	10	12	14

¹⁾ Filling of the annular gap according annex B 5.

²⁾ $N^0_{Rk,c}$ according EN 1992-4:2018

fischer concrete screw ULTRACUT FBS II	Annex C 3 Appendix 15/ 19
Performances Characteristic values for seismic performance category C1	

Table C4.1: Characteristic values for seismic performance category C2

Size			FBS II			
			8	10	12	14
Nominal embedment depth	h_{nom}	[mm]	65	85	100	115
Steel failure for tension load and shear load						
Characteristic resistance	$N_{Rk,s,C2}$	[kN]	35,0	55	76,0	103
	$V_{Rk,s,C2}$		13,3	20,4	29,9	35,2
With filling of the annular gap ¹⁾	α_{gap}	[-]	1,0			
Pullout failure						
Characteristic resistance in cracked concrete	$N_{Rk,p,C2}$	[kN]	2,1	6,0	8,9	17,1
Concrete cone failure						
Effective embedment depth	h_{ef}	[mm]	52	68	81	93
Characteristic edge distance	$c_{cr,N}$		1,5 h_{ef}			
Characteristic spacing	$s_{cr,N}$		3 h_{ef}			
Installation factor	γ_{inst}	[-]	1,0			
Concrete pryout failure						
Factor for pryout failure	k_8	[-]	2,0			
Concrete edge failure						
Effective length in concrete	l_f	[mm]	65	85	100	115
Nominal diameter of screw	d_{nom}		8	10	12	14

¹⁾ Filling of the annular gap according annex B 5. Application without filling of the annular gap not allowed.

fischer concrete screw ULTRACUT FBS II

Performances

Characteristic values for seismic performance category C2 with FBS II 8 - 14

Annex C 4

Appendix 16/ 19

Table C5.1: Characteristic values for resistance to fire with FBS II 6¹⁾

FBS II 6							
Nominal embedment depth	h_{nom}	[mm]	40	45	50	55	
Steel failure for tension load and shear load							
Characteristic resistance for all head shapes	$N_{Rk,s,fi}$	R30	[kN]	1,00			
		R60		0,60			
		R90		0,50			
		R120		0,40			
	$V_{Rk,s,fi}$	R30		1,00			
		R60		0,60			
		R90		0,50			
		R120		0,40			
Characteristic bending resistance for all head shapes	$M^0_{Rk,s,fi}$	R30	[Nm]	0,80			
		R60		0,50			
		R90		0,40			
		R120		0,35			
Pullout failure							
Characteristic resistance	$N_{Rk,p,fi}$	R30	[kN]	0,6	0,9	1,0	
		R60					1,2
		R90					
		R120					
				0,5	0,7	0,8	
Edge distance							
R30 to R120	$C_{cr,fi}$	[mm]	2 h_{ef}				
In case of fire attack from more than one side, the minimum edge distance shall be ≥ 300 mm							
Spacing							
R30 to R120	$S_{cr,fi}$	[mm]	2 $C_{cr,fi}$				
¹⁾ The embedment depth has to be increased for wet concrete by at least 30 mm compared to the given value.							
fischer concrete screw ULTRACUT FBS II						Annex C 5	
Performances Characteristic values for resistance to fire with FBS II 6							
						Appendix 17/ 19	

Table C6.1: Characteristic values for resistance to fire with FBS II 8 – 14 ¹⁾

Size		FBS II																							
		8		10			12			14															
Nominal embedment depth		h_{nom}	[mm]	50	65	55	65	85	60	75	100	65	85	115											
Steel failure for tension load and shear load																									
Characteristic resistance for the head shapes	US, S	$N_{Rk,s,fi}$	R30	[kN]	2,33		3,45			4,62			6,46												
			R60		1,82		2,73			3,66			5,11												
			R90		1,30		2,00			2,69			3,75												
			R120		1,04		1,64			2,20			3,08												
		$V_{Rk,s,fi}$	R30	2,33		3,45			4,62			6,46													
			R60	1,82		2,73			3,66			5,11													
			R90	1,30		2,00			2,69			3,75													
			R120	1,04		1,64			2,20			3,08													
	SK, US TX, S TX	$N_{Rk,s,fi}$	R30	2,12		2,96			No performance declared																
			R60	1,67		2,26																			
			R90	1,21		1,56																			
			R120	0,99		1,21																			
		$V_{Rk,s,fi}$	R30	2,12		2,96																			
			R60	1,67		2,26																			
			R90	1,21		1,56																			
			R120	0,99		1,21																			
	All head shapes	$M^0_{Rk,s,fi}$	i	[Nm]	R30	2,62		4,92			7,83			12,89											
					R60	2,05		3,89			6,20			10,19											
					R90	1,46		2,85			4,56			7,48											
					R120	1,17		2,34			3,73			6,14											
Pullout failure																									
Characteristic resistance	$N_{Rk,p,fi}$	R30	[kN]	1,5		3,0		2,3		3,0		5,0		2,9		4,2		6,6		3,2		4,9		8,1	
		R60		1,2		2,4		1,8		2,4		4,0		2,3		3,3		5,2		2,5		3,9		6,5	
		R90																							
		R120																							
Edge distance																									
R30 to R120		$c_{cr,fi}$	[mm]	$2 h_{ef}$																					
In case of fire attack from more than one side, the minimum edge distance shall be ≥ 300 mm																									
Spacing																									
R30 to R120		$s_{cr,fi}$	[mm]	$2 c_{cr,fi}$																					
¹⁾ The embedment depth has to be increased for wet concrete by at least 30 mm compared to the given value.																									
fischer concrete screw ULTRACUT FBS II													Annex C 6												
Performances Characteristic values for resistance to fire with FBS II 8 - 14																									
													Appendix 18/ 19												

Table C7.1: Displacements due to tension loads (static)

Size			FBS II												
			6 ¹⁾		8		10			12			14		
Nominal embedment depth	h_{nom}	[mm]	40	55	50	65	55	65	85	60	75	100	65	85	115
Tension load in cracked concrete	N	[kN]	2,0	3,5	2,9	5,7	4,3	5,7	9,6	5,5	8,0	12,5	6,1	9,4	15,3
Displacement	$\frac{\delta_{N0}}{\delta_{N\infty}}$	[mm]	1,1	1,4	0,5	0,9	0,7	0,7	0,8	0,7	0,9	0,8	0,8	1,0	0,8
			2,5	2,5	1,3	1,0	0,7	0,7	0,8	1,3	0,9	0,8	1,1	1,0	1,1
Tension load in uncracked concrete	N	[kN]	4,0	7,0	7,9	12,0	6,8	8,8	13,5	7,7	11,0	17,4	8,5	13,2	21,6
Displacement	$\frac{\delta_{N0}}{\delta_{N\infty}}$	[mm]	1,0	1,8	0,9	1,4	0,9	0,9	1,4	0,9	1,1	1,4	1,0	1,3	1,1
			1,7	2,6	1,4	1,4	1,4	1,4	1,4	1,4	1,4	1,4	1,1	1,3	1,1

¹⁾ Intermediate values by linear interpolation

Table C7.2: Displacements due to shear loads (static)

Size			FBS II												
			6 ¹⁾		8		10			12			14		
Nominal embedment depth	h_{nom}	[mm]	40	55	50	65	55	65	85	60	75	100	65	85	115
Shear load in cracked and uncracked concrete	V	[kN]	4,5	6,7	6,2	9,0	14,0	14,0	16,6	15,9	15,9	21,2	23,0	23,0	30,5
Displacement	$\frac{\delta_{V0}}{\delta_{V\infty}}$	[mm]	2,0	2,9	1,4	1,4	3,2	3,2	3,2	2,5	2,5	3,4	2,8	2,8	5,4
			2,9	4,4	2,0	2,1	4,9	4,9	4,9	3,8	3,8	5,1	4,2	4,2	8,1

¹⁾ Intermediate values by linear interpolation

Table C7.3: Displacements due to tension loads (seismic performance category C2)

Size			FBS II			
			8	10	12	14
Nominal embedment depth	h_{nom}	[mm]	65	85	100	115
Displacement DLS	$\delta_{N,C2}$ (DLS)	[mm]	0,5	0,8	0,9	1,3
Displacement ULS	$\delta_{N,C2}$ (ULS)	[mm]	1,7	2,8	2,7	5,0

Table C7.4: Displacements due to shear loads (seismic performance category C2)

Size			FBS II			
			8	10	12	14
Nominal embedment depth	h_{nom}	[mm]	65	85	100	115
Displacement DLS	$\delta_{V,C2}$ (DLS)	[mm]	1,6	2,7	3,1	4,1
Displacement ULS	$\delta_{V,C2}$ (ULS)	[mm]	3,9	7,1	5,3	8,7

fischer concrete screw ULTRACUT FBS II

Performances

Displacements due to tension and shear loads

Annex C 7

Appendix 19/ 19