



DECLARATION OF PERFORMANCE



No. 0088 – EN

1. Unique identification code of the product-type: **fischer injection system FIS EM**

2. Intended use/es:

Product	Intended use/es
Bonded anchor for use in concrete	Post-installed fastening in cracked or uncracked concrete, see appendix, especially Annexes B 1 to B 11.

3. Manufacturer:

fischerwerke GmbH & Co. KG, Otto-Hahn-Straße 15, 79211 Denzlingen, Germany

4. Authorised representative: --

5. System/s of AVCP: **1**

6a. Harmonised standard: ---

Notified body/ies: ---

6b. European Assessment Document: **ETAG 001; 2016-04**

European Technical Assessment: **ETA-10/0012; 2016-09-12**

Technical Assessment Body: **DIBt**

Notified body/ies: **1343 – MPA Darmstadt**

7. Declared performance/s:

Mechanical resistance and stability (BWR 1)

Essential characteristic	Performance
Characteristic values under static and quasi-static action for design according to TR 029 or CEN/TS 1992-4:2009, Displacements	See appendix, especially Annexes C 1 to C 10
Characteristic resistance for seismic performance categories C1 and C2 for design according to Technical Report TR 045, Displacements	See appendix, especially Annexes C 11 to C 14

Safety in case of fire (BWR 2)

Essential characteristic	Performance
Reaction to fire	Anchorage satisfy requirements for Class A 1
Resistance to fire	NPD

8. Appropriate Technical Documentation and/or Specific Technical Documentation: ---

The performance of the product identified above is in conformity with the set of declared performance/s. This declaration of performance is issued, in accordance with Regulation (EU) No 305/2011, under the sole responsibility of the manufacturer identified above.

Signed for and on behalf of the manufacturer by:

Andreas Bucher, Dipl.-Ing.

Wolfgang Hengesbach, Dipl.-Ing., Dipl.-Wirtsch.-Ing.

Tumlingen, 2016-09-19

- This DoP has been prepared in different languages. In case there is a dispute on the interpretation the english version shall always prevail.

- The Appendix includes voluntary and complementary information in English language exceeding the (language-neutrally specified) legal requirements.

Specific Part

1 Technical description of the product

The fischer injection system FIS EM is a bonded anchor consisting of a cartridge with injection mortar fischer FIS EM and a steel element according to Annex A2.

The steel element is placed into a drilled hole filled with injection mortar and is anchored via the bond between metal part, injection mortar and concrete.

The product description is given in Annex A.

2 Specification of the intended use in accordance with the applicable European Assessment Document

The performances given in Section 3 are only valid if the anchor is used in compliance with the specifications and conditions given in Annex B.

The verifications and assessment methods on which this European Technical Assessment is based lead to the assumption of a working life of the anchor of at least 50 years. The indications given on the working life cannot be interpreted as a guarantee given by the producer, but are to be regarded only as a means for choosing the right products in relation to the expected economically reasonable working life of the works.

3 Performance of the product and references to the methods used for its assessment

3.1 Mechanical resistance and stability (BWR 1)

Essential characteristic	Performance
Characteristic values under static and quasi-static action for design according to TR 029 or CEN/TS 1992-4:2009, Displacements	See Annex C 1 to C 10
Characteristic values for seismic performance categories C1 and C2 for design according to Technical Report TR 045, Displacements	See Annex C 11 to C 14

3.2 Safety in case of fire (BWR 2)

Essential characteristic	Performance
Reaction to fire	Anchorage satisfy requirements for Class A1
Resistance to fire	No performance assessed

3.3 Hygiene, health and the environment (BWR 3)

Regarding dangerous substances there may be requirements (e.g. transposed European legislation and national laws, regulations and administrative provisions) applicable to the products falling within the scope of this European Technical Assessment. In order to meet the provisions of Regulation (EU) No 305/2011, these requirements need also to be complied with, when and where they apply.

3.4 Safety in use (BWR 4)

The essential characteristics regarding Safety in use are included under the Basic Works Requirement Mechanical resistance and stability.

4 Assessment and verification of constancy of performance (AVCP) system applied, with reference to its legal base

In accordance with guideline for European technical approval ETAG 001, April 2013 used as European Assessment Document (EAD) according to Article 66 Paragraph 3 of Regulation (EU) No 305/2011 the applicable European legal act is: [96/582/EC].

The system to be applied is: 1

Installation conditions

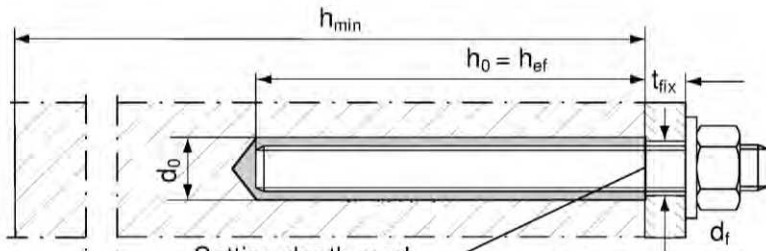

Anchor rod
Pre-positioned anchor

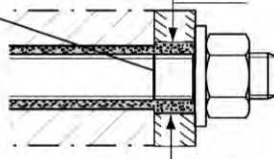

Anchor rod
Push through anchor
(annular gap filled with mortar)

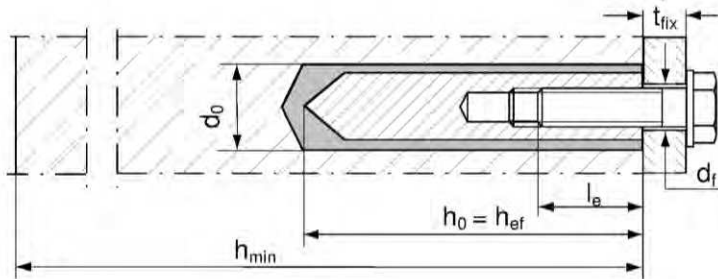

fischer
internal threaded anchor RG MI
Pre-positioned anchor only

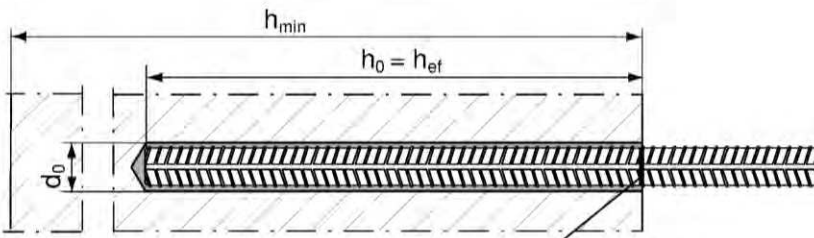

Reinforcing bar

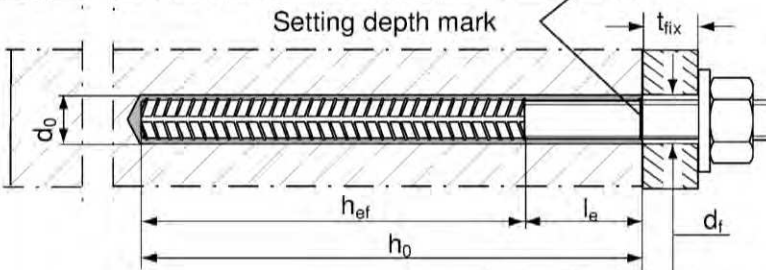

fischer rebar anchor FRA
Pre-positioned anchor

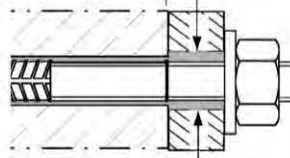

fischer rebar anchor FRA
Push through anchor
(annular gap filled with mortar)

fischer injection system FIS EM

Product description
Installation conditions

Annex A 1

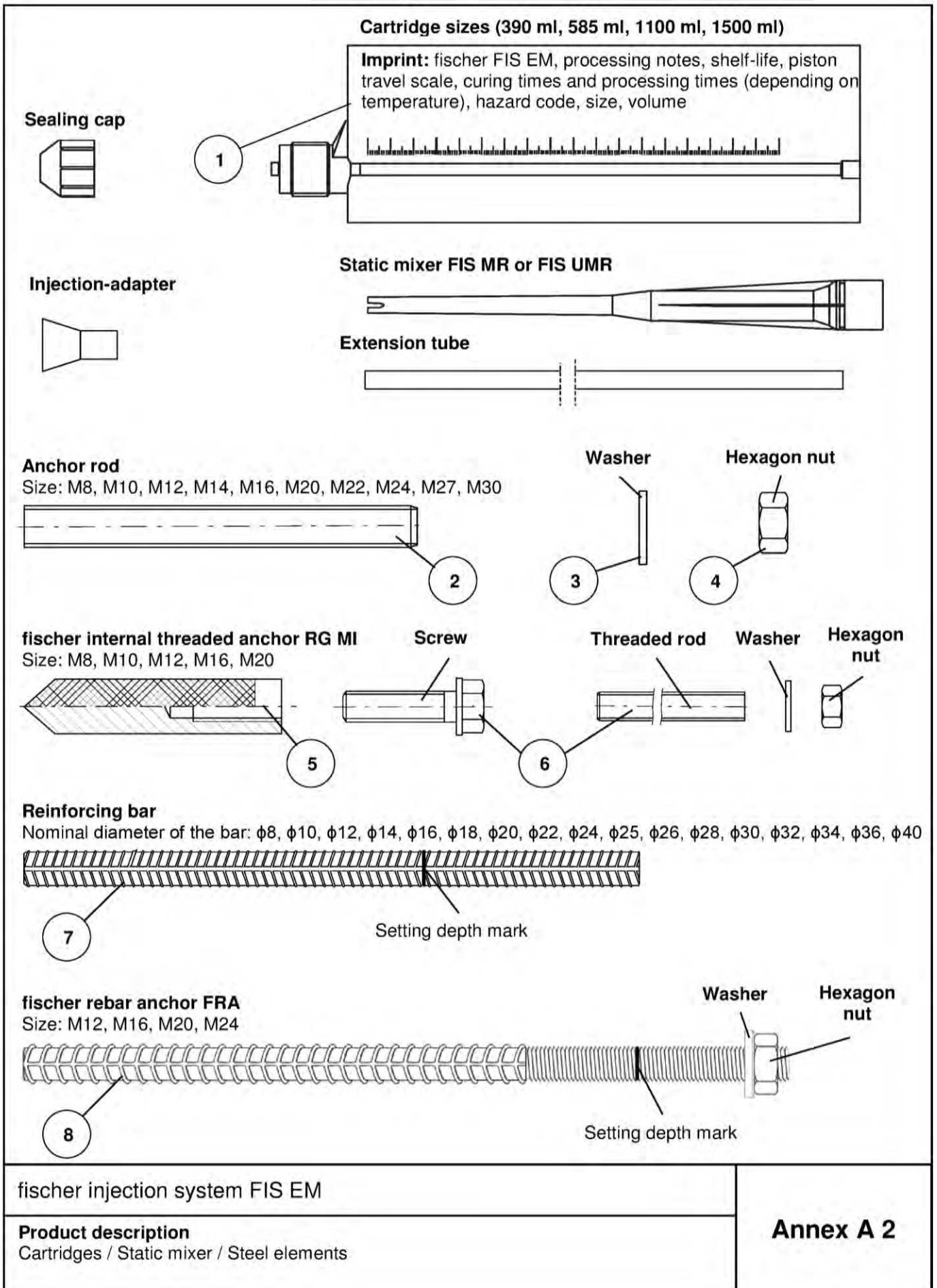









Table A1: Materials				
Part	Designation	Material		
1	Mortar cartridge	Mortar, hardener, filler		
	Steel grade	Steel, zinc plated	Stainless steel A4	High corrosion resistant steel C
2	Anchor rod	Property class 5.8 or 8.8; EN ISO 898-1:2013 zinc plated $\geq 5 \mu\text{m}$, EN ISO 4042:1999 A2K or hot-dip galvanised EN ISO 10684:2004 $f_{uk} \leq 1000 \text{ N/mm}^2$ $A_5 > 12 \%$ fracture elongation ¹⁾	Property class 50, 70 or 80 EN ISO 3506-1:2009 1.4401; 1.4404; 1.4578; 1.4571; 1.4439; 1.4362; 1.4062, 1.4662, 1.4462 EN 10088-1:2014 $f_{uk} \leq 1000 \text{ N/mm}^2$ $A_5 > 12 \%$ fracture elongation ¹⁾	Property class 50 or 80 EN ISO 3506-1:2009 or property class 70 with $f_{yk} = 560 \text{ N/mm}^2$ 1.4565; 1.4529 EN 10088-1:2014 $f_{uk} \leq 1000 \text{ N/mm}^2$ $A_5 > 12 \%$ fracture elongation ¹⁾
3	Washer ISO 7089:2000	zinc plated $\geq 5 \mu\text{m}$, EN ISO 4042:1999 A2K or hot-dip galvanised EN ISO 10684:2004	1.4401; 1.4404; 1.4578; 1.4571; 1.4439; 1.4362 EN 10088-1:2014	1.4565; 1.4529 EN 10088-1:2014
4	Hexagon nut	Property class 5 or 8; EN ISO 898-2:2012 zinc plated $\geq 5 \mu\text{m}$, ISO 4042:1999 A2K or hot-dip galvanised EN ISO 10684:2004	Property class 50, 70 or 80 EN ISO 3506-1:2009 1.4401; 1.4404; 1.4578; 1.4571; 1.4439; 1.4362 EN 10088-1:2014	Property class 50, 70 or 80 EN ISO 3506-1:2009 1.4565; 1.4529 EN 10088-1:2014
5	fischer internal threaded anchor RG MI	Property class 5.8 ISO 898-1:2013 zinc plated $\geq 5 \mu\text{m}$, ISO 4042:1999 A2K	Property class 70 EN ISO 3506-1:2009 1.4401; 1.4404; 1.4578; 1.4571; 1.4439; 1.4362 EN 10088-1:2014	Property class 70 EN ISO 3506-1:2009 1.4565; 1.4529 EN 10088-1:2014
6	Screw or anchor / threaded rod for fischer internal threaded anchor RG MI	Property class 5.8 or 8.8; EN ISO 898-1:2013 zinc plated $\geq 5 \mu\text{m}$, ISO 4042:1999 A2K fracture elongation $A_5 > 8 \%$	Property class 70 EN ISO 3506-1:2009 1.4401; 1.4404; 1.4578; 1.4571; 1.4439; 1.4362 EN 10088-1:2014 fracture elongation $A_5 > 8 \%$	Property class 70 EN ISO 3506-1:2009 1.4565; 1.4529 EN 10088-1:2014 fracture elongation $A_5 > 8 \%$
7	Reinforcing bar EN 1992-1-1:2004 and AC:2010, Annex C	Bars and de-coiled rods, class B or C with f_{yk} and k according to NDP or NCL of EN 1992-1-1:2004+AC:2010 $f_{uk} = f_{tk} = k \cdot f_{yk}$		
8	fischer rebar anchor FRA	Rebar part: Bars and de-coiled rods class B or C with f_{yk} and k according to NDP or NCL of EN 1992-1-1:2004+AC:2010 $f_{uk} = f_{tk} = k \cdot f_{yk}$	Threaded part: Property class 70 or 80 EN ISO 3506-1:2009 1.4565; 1.4529, 1.4401, 1.4404, 1.4571, 1.4578, 1.4439, 1.4362, 1.4062 EN 10088-1:2014	
¹⁾ Fracture elongation $A_5 > 8 \%$ for applications without requirements for seismic performance				
fischer injection system FIS EM				Annex A 3
Product description Materials				

Specifications of intended use (part 1)

Table B1: Overview use and performance categories

Anchorages subject to		FIS EM with ...							
		Anchor rod 	fischer internal threaded anchor RG MI 	Reinforcing bar 	fischer rebar anchor FRA 				
Hammer drilling with standard drill bit 		all sizes							
Hammer drilling with hollow drill bit (Heller "Duster Expert" or Hilti "TE-CD, TE-YD") 		Nominal drill bit diameter (d_0) 12 mm to 35 mm							
Diamond drilling 		all sizes							
Static and quasi static load, in	uncracked concrete	all sizes	Tables: C1, C5, C6, C10	all sizes	Tables: C2, C5, C7, C11	all sizes	Tables: C3, C5, C8, C12	all sizes	Tables: C4, C5, C9, C13
	cracked concrete								
Seismic performance category (only hammer drilling with Standard / hollow drill bits)	C1	M10 to M30	Tables: C14, C16, C17	---		$\phi 10$ to $\phi 32$	Tables: C15, C16, C18	---	
	C2	M12, M16, M20, M24	Tables: C14, C16, C19			---	---		
Use category	dry or wet concrete	all sizes							
	flooded hole	all sizes							
Installation temperature		+5 °C to +40 °C							
In-service temperature	Temperature range I	-40 °C to +60 °C	(max. long term temperature +35 °C and max. short term temperature +60 °C)						
	Temperature range II	-40 °C to +72 °C	(max. long term temperature +50 °C and max. short term temperature +72 °C)						
fischer injection system FIS EM									Annex B 1
Intended Use Specifications (part 1)									

Specifications of intended use (part 2)

Base materials:

- Reinforced or unreinforced normal weight concrete Strength classes C20/25 to C50/60 according to EN 206-1:2000

Use conditions (Environmental conditions):

- Structures subject to dry internal conditions (zinc coated steel, stainless steel or high corrosion resistant steel)
- Structures subject to external atmospheric exposure (including industrial and marine environment) and to permanently damp internal condition, if no particular aggressive conditions exist (stainless steel or high corrosion resistant steel)
- Structures subject to external atmospheric exposure, to permanently damp internal conditions or in other particular aggressive conditions (high corrosion resistant steel)

Note: Particular aggressive conditions are e.g. permanent, alternating immersion in seawater or the splash zone of seawater, chloride atmosphere of indoor swimming pools or atmosphere with extreme chemical pollution (e.g. in desulphurization plants or road tunnels where de-icing materials are used)

Design:

- Anchorages have to be designed by a responsible engineer with experience of concrete anchor design
- Verifiable calculation notes and drawings are to be prepared taking account of the loads to be anchored. The position of the anchor is indicated on the design drawings (e.g. position of the anchor relative to reinforcement or to supports, etc.)
- Anchorages under static or quasi-static actions are designed in accordance with EOTA Technical Report TR 029 "Design of bonded anchors" Edition September 2010 or CEN/TS 1992-4:2009
- Anchorages under seismic actions (cracked concrete) have to be designed in accordance with:
 - EOTA Technical Report TR 045 "Design of Metal Anchors under Seismic Action", Edition February 2013
 - Anchorages shall be positioned outside of critical regions (e.g. plastic hinges) of the concrete structure
 - Fastenings in stand-off installation or with a grout layer are not allowed

Installation:

- Anchor installation is to be carried out by appropriately qualified personnel and under the supervision of the person responsible for technical matters of the site
- In case of aborted hole: The hole shall be filled with mortar
- Anchorage depth should be marked and adhered to on installation
- Overhead installation is allowed

fischer injection system FIS EM

Intended Use
Specifications (part 2)

Annex B 2

Table B2: Installation parameters for anchor rods

Size		M8	M10	M12	M14	M16	M20	M22	M24	M27	M30
Width across flats	SW	13	17	19	22	24	30	32	36	41	46
Nominal drill bit diameter	d_0	12	14	14	16	18	24	25	28	30	35
Drill hole depth	h_0	$h_0 = h_{ef}$									
Effective anchorage depth	$h_{ef,min}$	60	60	70	75	80	90	93	96	108	120
	$h_{ef,max}$	160	200	240	280	320	400	440	480	540	600
Minimum spacing and minimum edge distance	s_{min}	40	45	55	60	65	85	95	105	120	140
	c_{min}										
Diameter of clearance hole in the fixture ¹⁾	pre-positioned anchorage d_f	9	12	14	16	18	22	24	26	30	33
	push through anchorage d_f	14	16	16	18	20	26	28	30	33	40
Minimum thickness of concrete member	h_{min}	$h_{ef} + 30$ (≥ 100)			$h_{ef} + 2d_0$						
Maximum installation torque	$T_{inst,max}$ [Nm]	10	20	40	50	60	120	135	150	200	300

¹⁾ For larger clearance holes in the fixture see TR 029, 4.2.2.1 or CEN/TS 1992-4-1:2009, 5.2.3.1

Anchor rod:

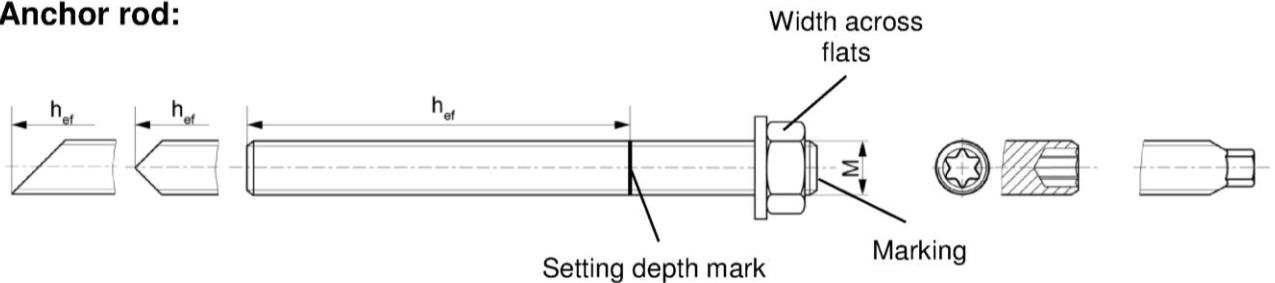

Marking (on random place) fischer anchor rod:

Property class 8.8, stainless steel, property class 80 or high corrosion resistant steel, property class 80: •
 Stainless steel A4, property class 50 and high corrosion resistant steel, property class 50: ••
 Or colour coding according to DIN 976-1

Commercial standard threaded rods, washers and hexagon nuts may also be used if the following requirements are fulfilled:

- Materials, dimensions and mechanical properties according Annex A 3, Table A1
- Inspection certificate 3.1 according to EN 10204:2004, the documents have to be stored
- Setting depth is marked

fischer injection system FIS EM

Intended Use
 Installation parameters anchor rods

Annex B 3

Table B3: Installation parameters for fischer internal threaded anchors RG MI

Size		M8	M10	M12	M16	M20
Diameter of anchor	d_H	12	16	18	22	28
Nominal drill bit diameter	d_0	14	18	20	24	32
Drill hole depth	h_0	$h_0 = h_{ef}$				
Effective anchorage depth ($h_{ef} = L_H$)	h_{ef}	90	90	125	160	200
Minimum spacing and minimum edge distance	$s_{min} = c_{min}$	55	65	75	95	125
Diameter of clearance hole in the fixture ¹⁾	d_f	9	12	14	18	22
Minimum thickness of concrete member	h_{min}	120	125	165	205	260
Maximum screw-in depth	$l_{E,max}$	18	23	26	35	45
Minimum screw-in depth	$l_{E,min}$	8	10	12	16	20
Maximum installation torque	$T_{inst,max}$ [Nm]	10	20	40	80	120

¹⁾ For larger clearance holes in the fixture see TR 029, 4.2.2.1 or CEN/TS 1992-4-1:2009, 5.2.3.1

fischer internal threaded anchor RG MI

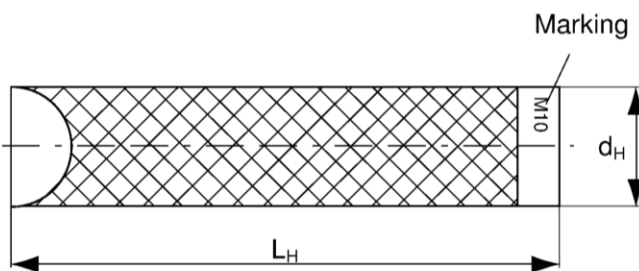
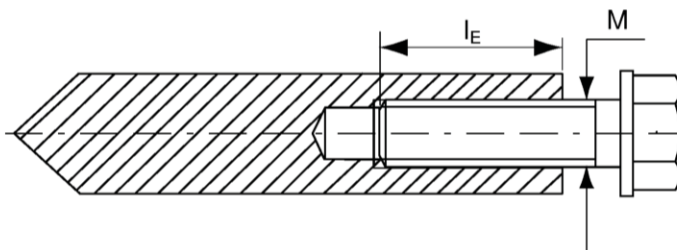

Marking: Anchor size
e.g.: **M10**

Stainless steel additional **A4**
e.g.: **M10 A4**

High corrosion resistant steel additional **C**
e.g.: **M10 C**

Retaining bolt or threaded rods (including nut and washer) must comply with the appropriate material and strength class of Annex A 3, Table A1

fischer injection system FIS EM

Intended Use
Installation parameters fischer internal threaded anchors RG MI

Annex B 4

Table B4: Installation parameters for reinforcing bars

Nominal diameter of the bar		ϕ	8 ¹⁾		10 ¹⁾		12 ¹⁾		14	16	18	20	22	24	
Nominal drill bit diameter	d_0	[mm]	10	12	12	14	14	16	18	20	25	25	30	30	
Drill hole depth	h_0		$h_0 = h_{ef}$												
Effective anchorage depth	$h_{ef,min}$		60	60	70	75	80	85	90	94	98				
	$h_{ef,max}$		160	200	240	280	320	360	400	440	480				
Minimum spacing and minimum edge distance	$s_{min} = c_{min}$		40	45	55	60	65	75	85	95	105				
	h_{min}		$h_{ef} + 30$ (≥ 100)				$h_{ef} + 2d_0$								
Nominal diameter of the bar		ϕ	25	26	28	30	32	34	36	40	---				
Nominal drill bit diameter	d_0	[mm]	30	35	35	40	40	40	45	55	---				
Drill hole depth	h_0		$h_0 = h_{ef}$												
Effective anchorage depth	$h_{ef,min}$		100	104	112	120	128	136	144	160	---				
	$h_{ef,max}$		500	520	560	600	640	680	720	800	---				
Minimum spacing and minimum edge distance	$s_{min} = c_{min}$		110	120	130	140	160	170	180	200	---				
	h_{min}		$h_{ef} + 2d_0$												

¹⁾ Both drill bit diameters can be used

Reinforcing bar

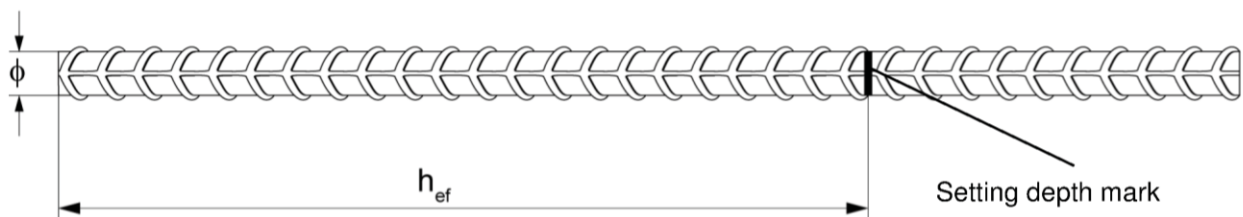

- The minimum value of related rib area $f_{R,min}$ must fulfil the requirements of EN 1992-1-1:2004+AC:2010
- The rib height must be within the range: $0,05 \cdot \phi \leq h_{rib} \leq 0,07 \cdot \phi$
(ϕ = Nominal diameter of the bar , h_{rib} = rib height)

fischer injection system FIS EM

Intended Use
Installation parameters reinforcing bars

Annex B 5

Table B5: Installation parameters for fischer rebar anchor FRA



Size		M12 ¹⁾	M16	M20	M24
Nominal diameter of the bar	ϕ	12	16	20	25
Width across flats	SW	19	24	30	36
Nominal drill bit diameter	d_0	14 16	20	25	30
Drill hole depth	h_0	$h_{ef} + l_e$			
Effective anchorage depth	$h_{ef,min}$	70	80	90	96
	$h_{ef,max}$	140	220	300	380
Distance concrete surface to welded joint	l_e	100			
Minimum spacing and minimum edge distance	s_{min} = c_{min}	55	65	85	105
	Diameter of clearance hole in the fixture ²⁾	$\leq d_f$	14	18	22
	push through anchorage	$\leq d_f$	18	22	26
Minimum thickness of concrete member	h_{min}	$h_0 + 30$ (≥ 100)	$h_0 + 2d_0$		
Maximum installation torque	$T_{inst,max}$ [Nm]	40	60	120	150

¹⁾ Both drill bit diameters can be used

²⁾ For larger clearance holes in the fixture see TR 029, 4.2.2.1 or CEN/TS 1992-4-1:2009, 5.2.3.1

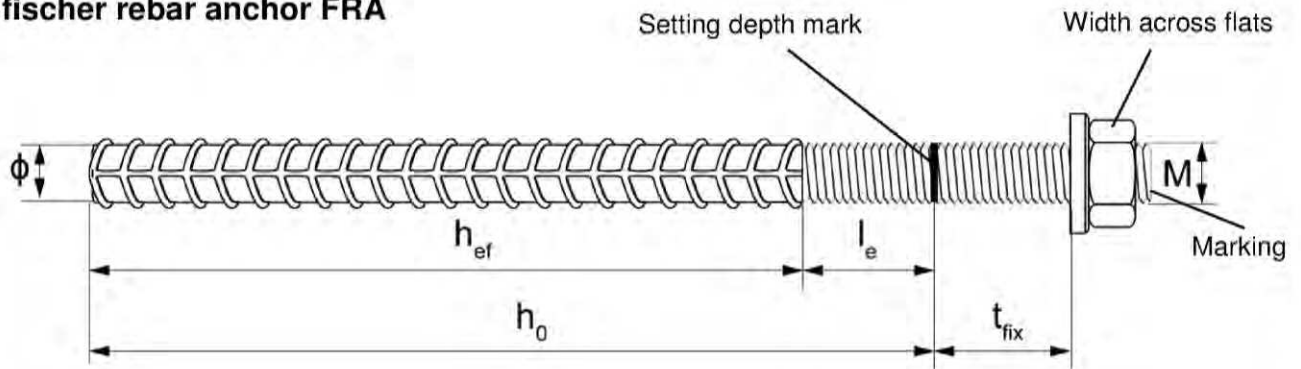
fischer rebar anchor FRA



Marking frontal e.g.:  FRA (for stainless steel);
 FRA C (for high corrosion resistant steel)

fischer injection system FIS EM

Intended Use
Installation parameters rebar anchor FRA

Annex B 6

Table B6: Parameters of steel brush FIS BS / BSB Ø

		FIS BS											FIS BSB			
Drill bit diameter	d_0	[mm]	12	14	16	18	20	24	25	28	30	32	35	40	45	55
Steel brush diameter	d_b		14	16	20	25	26	27	30	40			42	47	58	

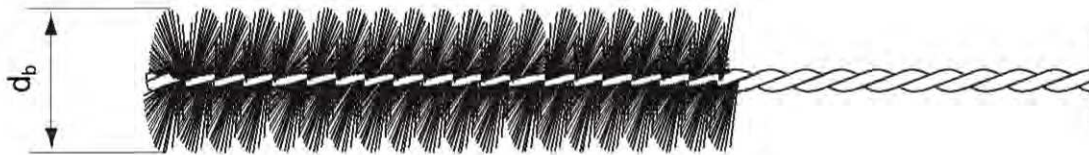

Table B7: Maximum processing time of the mortar and minimum curing time
 (During the curing time of the mortar the concrete temperature may not fall below the listed minimum temperature)

System temperature [°C]	Maximum processing time t_{work} [minutes]	Minimum curing time ¹⁾ t_{cure} [hours]
+5 to +10	120	40
≥ +10 to +20	30	18
≥ +20 to +30	14	10
≥ +30 to +40	7	5

¹⁾ In wet concrete or flooded holes the curing times must be doubled





fischer injection system FIS EM

Intended Use
 Cleaning tools
 Processing times and curing times

Annex B 7

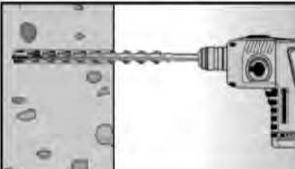
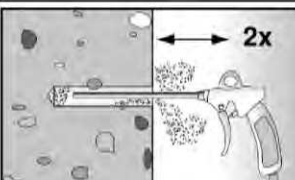
Installation instructions part 1

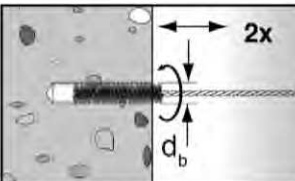
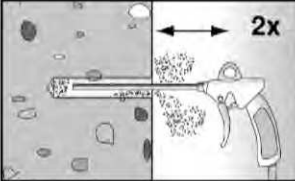
Drilling and cleaning the hole (hammer drilling with standard drill bit)

1		<p>Drill the hole. Drill hole diameter d_0 and drill hole depth h_0 see Tables B2, B3, B4, B5</p>
2		<p>Blow out the drill hole twice, with oil-free compressed air ($p \geq 6$ bar)</p> 
3		<p>Brush the drill hole twice. For drill hole diameter ≥ 30 mm use a power drill. For deep holes use an extension. Corresponding brushes see Table B6</p>
4		<p>Blow out the drill hole twice, with oil-free compressed air ($p \geq 6$ bar)</p> 

Go to step 6

Drilling and cleaning the hole (hammer drilling with hollow drill bit)

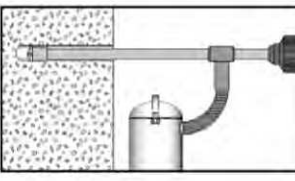
1		<p>Check a suitable hollow drill (see Table B1) for correct operation of the dust extraction</p>
2		<p>Use a suitable dust extraction system, e.g. Bosch GAS 35 M AFC or a comparable dust extraction system with equivalent performance data</p> <p>Drill the hole with hollow drill bit. The dust extraction system has to extract the drill dust nonstop during the drilling process. Diameter of drill hole d_0 and drill hole depth h_0 see Tables B2, B3, B4, B5</p>

Go to step 6

fischer injection system FIS EM

Intended use
Installation instructions part 1



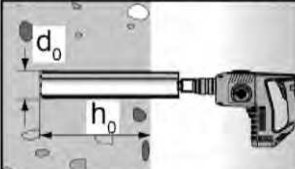
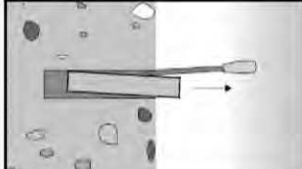
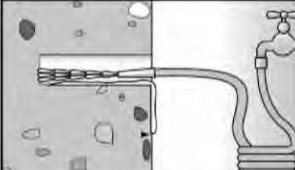
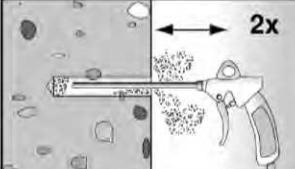
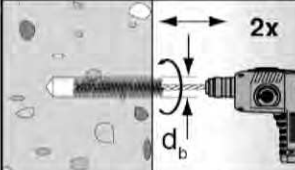
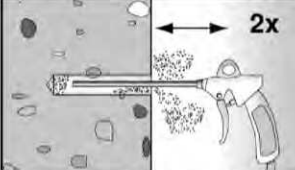

Annex B 8

Installation instructions part 2

Drilling and cleaning the hole (wet drilling with diamond drill bit)

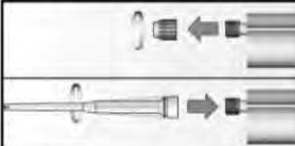
1		<p>Drill the hole. Drill hole diameter d_0 and drill hole depth h_0 see Tables B2, B3, B4, B5</p>	 <p>Break the drill core and draw it out</p>
2		<p>Flush the drill hole with clean water until it flows clear</p>	
3		<p>Blow out the drill hole twice, using oil-free compressed air ($p > 6$ bar)</p>	
4		<p>Brush the drill hole twice using a power drill. Corresponding brushes see Table B6</p>	
5		<p>Blow out the drill hole twice, using oil-free compressed air ($p > 6$ bar)</p>	

Preparing the cartridge

6			<p>Remove the sealing cap Screw on the static mixer (the spiral in the static mixer must be clearly visible)</p>
7			<p>Place the cartridge into the dispenser</p>
8			<p>Extrude approximately 10 cm of material out until the resin is evenly grey in colour. Do not use mortar that is not uniformly grey</p>

fischer injection system FIS EM

Intended use
Installation instructions part 2



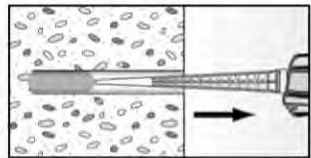
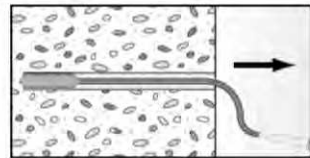
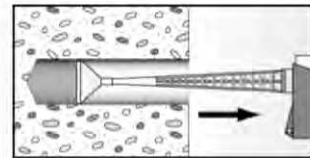

Annex B 9

Installation instructions part 3

Injection of the mortar

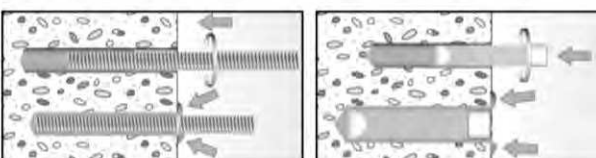
<p>9</p>	 <p>Fill approximately 2/3 of the drill hole with mortar. Always begin from the bottom of the hole and avoid bubbles</p>	 <p>For drill hole depth ≥ 150 mm use an extension tube</p>	 <p>For overhead installation, deep holes $h_0 > 250$ mm or drill hole diameter $d_0 \geq 40$ mm use an injection-adapter</p>
----------	---	--	---

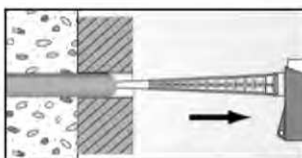
Installation of anchor rods or fischer internal threaded anchors RG MI

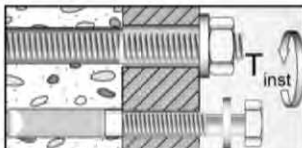
<p>10</p>		<p>Only use clean and oil-free anchor elements. Mark the setting depth of the anchor. Press the threaded rod or fischer internal threaded RG MI anchor down to the bottom of the hole, turning it slightly while doing so. After inserting the anchor element, excess mortar must be emerged around the anchor element</p>
	 <p>For overhead installations support the anchor rod with wedges. (e.g. fischer centering wedges)</p>	 <p>For push through installation fill the annular gap with mortar</p>
<p>11</p>	 <p>Wait for the specified curing time t_{cure} see Table B7</p>	<p>12</p>  <p>Mounting the fixture $T_{inst,max}$ see Tables B2 and B3</p>



fischer injection system FIS EM

Intended use
Installation instructions part 3

Annex B 10

Installation instructions part 4

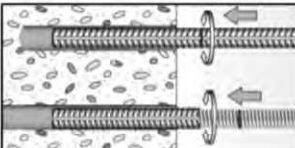
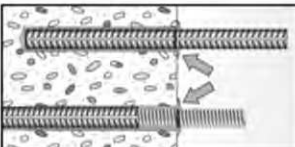
Installation reinforcing bars and fischer rebar anchor FRA

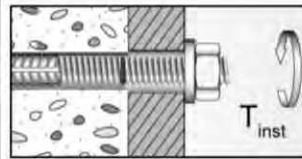
10		<p>Only use clean and oil-free reinforcing bars or fischer FRA. Mark the setting depth. Turn while using force to push the reinforcement bar or the fischer FRA into the filled hole up to the setting depth mark</p>		
10		<p>When the setting depth mark is reached, excess mortar must be emerged from the mouth of the drill hole</p>		
11	 <p>Wait for the specified curing time t_{cure} see Table B7</p>	12		<p>Mounting the fixture $T_{inst,max}$ see Table B5</p>

fischer injection system FIS EM

Intended use
Installation instructions part 4

Annex B 11

Table C1: Characteristic values for the steel bearing capacity under tensile / shear load of fischer anchor rods and standard threaded rods

Size		M8	M10	M12	M14	M16	M20	M22	M24	M27	M30			
Bearing capacity under tensile load, steel failure														
Charact. bearing capacity $N_{Rk,s}$	Steel zinc plated	5.8	Property class	[kN]	19	29	43	58	79	123	152	177	230	281
		8.8			29	47	68	92	126	196	243	282	368	449
	Stainless steel A4 and High corrosion resistant steel C	50			19	29	43	58	79	123	152	177	230	281
		70			26	41	59	81	110	172	212	247	322	393
		80			30	47	68	92	126	196	243	282	368	449
Partial safety factors¹⁾														
Partial safety factor $\gamma_{Ms,N}$	Steel zinc plated	5.8	Property class	[-]	1,50									
		8.8			1,50									
	Stainless steel A4 and High corrosion resistant steel C	50			2,86									
		70			1,50 ²⁾ / 1,87									
		80			1,60									
Bearing capacity under shear load, steel failure														
without lever arm														
Charact. bearing capacity $V_{Rk,s}$	Steel zinc plated	5.8	Property class	[kN]	9	15	21	29	39	61	76	89	115	141
		8.8			15	23	34	46	63	98	122	141	184	225
	Stainless steel A4 and High corrosion resistant steel C	50			9	15	21	29	39	61	76	89	115	141
		70			13	20	30	40	55	86	107	124	161	197
		80			15	23	34	46	63	98	122	141	184	225
Ductility factor acc. to CEN/TS 1992-4-5:2009 Section 6.3.2.1	k_2	[-]	1,0											
with lever arm														
Charact. bending moment $M_{Rk,s}^0$	Steel zinc plated	5.8	Property class	[Nm]	19	37	65	104	166	324	447	560	833	1123
		8.8			30	60	105	167	266	519	716	896	1333	1797
	Stainless steel A4 and High corrosion resistant steel C	50			19	37	65	104	166	324	447	560	833	1123
		70			26	52	92	146	232	454	626	784	1167	1573
		80			30	60	105	167	266	519	716	896	1333	1797
Partial safety factors¹⁾														
Partial safety factor $\gamma_{Ms,V}$	Steel zinc plated	5.8	Property class	[-]	1,25									
		8.8			1,25									
	Stainless steel A4 and High corrosion resistant steel C	50			2,38									
		70			1,25 ²⁾ / 1,56									
		80			1,33									

¹⁾ In absence of other national regulations

²⁾ Only admissible for steel C, with $f_{yk} / f_{uk} \geq 0,8$ and $A_5 > 12\%$ (e.g. fischer anchor rods)

fischer injection system FIS EM

Performances

Characteristic steel bearing capacity of fischer anchor rods and standard threaded rods

Annex C 1

Table C2: Characteristic values for the steel bearing capacity under tensile / shear load of fischer internal threaded anchors RG MI

Size			M8	M10	M12	M16	M20	
Bearing capacity under tensile load, steel failure								
Characteristic bearing capacity with screw	$N_{Rk,s}$	Property class 5.8	[kN]	19	29	43	79	123
		8.8		29	47	68	108	179
		Property class 70		26	41	59	110	172
		C		26	41	59	110	172
Partial safety factors¹⁾								
Partial safety factor	$\gamma_{Ms,N}$	Property class 5.8	[-]	1,50				
		8.8		1,50				
		Property class 70		1,87				
		C		1,87				
Bearing capacity under shear load, steel failure								
without lever arm								
Characteristic bearing capacity with screw	$V_{Rk,s}$	Property class 5.8	[kN]	9,2	14,5	21,1	39,2	62,0
		8.8		14,6	23,2	33,7	54,0	90,0
		Property class 70		12,8	20,3	29,5	54,8	86,0
		C		12,8	20,3	29,5	54,8	86,0
Ductility factor acc. to CEN/TS 1992-4-5:2009 Section 6.3.2.1			k_2	[-]	1,0			
with lever arm								
Characteristic bending moment with screw	$M_{Rk,s}^0$	Property class 5.8	[Nm]	20	39	68	173	337
		8.8		30	60	105	266	519
		Property class 70		26	52	92	232	454
		C		26	52	92	232	454
Partial safety factors¹⁾								
Partial safety factor	$\gamma_{Ms,V}$	Property class 5.8	[-]	1,25				
		8.8		1,25				1,25 / 1,50 ²⁾
		Property class 70		1,56				
		C		1,56				

¹⁾ In absence of other national regulations

²⁾ Only for steel failure without lever arm

fischer injection system FIS EM

Performances

Characteristic steel bearing capacity of fischer internal threaded anchor RG MI

Annex C 2

Table C3: Characteristic values for the steel bearing capacity under tensile / shear load of reinforcing bars

Nominal diameter of the bar	ϕ	8	10	12	14	16	18	20	22	24	25	26	28	30	32	34	36	40	
Bearing capacity under tensile load, steel failure																			
Characteristic bearing capacity	$N_{Rk,s}$	[kN]	$A_s \cdot f_{uk}^{1)}$																
Bearing capacity under shear load, steel failure																			
without lever arm																			
Characteristic bearing capacity	$V_{Rk,s}$	[kN]	$0,5 \cdot A_s \cdot f_{uk}^{1)}$																
Ductility factor acc. to CEN/TS 1992-4-5:2009 Section 6.3.2.1	k_2	[-]	0,8																
with lever arm																			
Characteristic bending moment	$M^0_{Rk,s}$	[Nm]	$1,2 \cdot W_{el} \cdot f_{uk}^{1)}$																

¹⁾ f_{uk} or f_{yk} respectively must be taken from the specifications of the reinforcing bar

Table C4: Characteristic values for the steel bearing capacity under tensile / shear load of fischer rebar anchors FRA

Size		M12	M16	M20	M24	
Bearing capacity under tensile load, steel failure						
Characteristic bearing capacity	$N_{Rk,s}$	[kN]	63	111	173	270
Partial safety factors¹⁾						
Partial safety factor	$\gamma_{Ms,N}$	[-]	1,4			
Bearing capacity under shear load, steel failure						
without lever arm						
Characteristic bearing capacity	$V_{Rk,s}$	[kN]	30	55	86	124
Ductility factor acc. to CEN/TS 1992-4-5:2009 Section 6.3.2.1	k_2	[-]	1,0			
with lever arm						
Characteristic bearing capacity	$M^0_{Rk,s}$	[Nm]	92	233	454	785
Partial safety factors¹⁾						
Partial safety factor	$\gamma_{Ms,V}$	[-]	1,56			

¹⁾ In absence of other national regulations

fischer injection system FIS EM

Performances

Characteristic steel bearing capacity of reinforcing bars and fischer rebar anchors FRA

Annex C 3

Table C5: General design factors for the bearing capacity under tensile / shear load; uncracked or cracked concrete

Size		All Sizes																	
Bearing capacity under tensile load																			
Factors acc. to CEN/TS 1992-4:2009 Section 6.2.2.3																			
Uncracked concrete	k_{ucr}	[-]	10,1																
Cracked concrete	k_{cr}		7,2																
Factors for the compressive strength of concrete > C20/25																			
Increasing factor for τ_{Rk}	C25/30	Ψ_c	[-]	1,02															
	C30/37			1,04															
	C35/45			1,06															
	C40/50			1,07															
	C45/55			1,08															
	C50/60			1,09															
Splitting failure																			
Edge distance	$h / h_{ef} \geq 2,0$	$C_{cr,sp}$	[mm]	1,0 h_{ef}															
	$2,0 > h / h_{ef} > 1,3$			4,6 $h_{ef} - 1,8 h$															
	$h / h_{ef} \leq 1,3$			2,26 h_{ef}															
Spacing	$S_{cr,sp}$			2 $C_{cr,sp}$															
Concrete cone failure acc. to CEN/TS 1992-4-5:2009 Section 6.2.3.2																			
Edge distance	$C_{cr,N}$	[mm]	1,5 h_{ef}																
Spacing	$S_{cr,N}$		2 $C_{cr,N}$																
Bearing capacity under shear load																			
Installation safety factors																			
All installation conditions	$\gamma_2 = \gamma_{inst}$	[-]	1,0																
Concrete pry-out failure																			
Factor k acc. to TR029 Section 5.2.3.3 resp. k_3 acc. to CEN/TS 1992-4-5:2009 Section 6.3.3	$k_{(3)}$	[-]	2,0																
Concrete edge failure																			
The value of h_{ef} (= l_f) under shear load		[mm]	min (h_{ef} ; 8d)																
Calculation diameters																			
Size			M8	M10	M12	M14	M16	M20	M22	M24	M27	M30							
fischer anchor rods and standard threaded rods	d	[mm]	8	10	12	14	16	20	22	24	27	30							
fischer internal threaded anchors RG MI	d		12	16	18	---	22	28	---	---	---	---							
fischer rebar anchors FRA	d		---	---	12	---	16	20	---	25	---	---							
Nominal diameter of the bar	ϕ		8	10	12	14	16	18	20	22	24	25	26	28	30	32	34	36	40
Reinforcing bar		[mm]	8	10	12	14	16	18	20	22	24	25	26	28	30	32	34	36	40
fischer injection system FIS EM												Annex C 4							
Performances General design factors relating to the characteristic bearing capacity under tensile / shear load																			

Table C6: Characteristic values of **resistance** for **fischer anchor rods** and **standard threaded rods** in hammer or diamond drilled holes; **uncracked or cracked concrete**

Size	M8	M10	M12	M14	M16	M20	M22	M24	M27	M30		
Combined pullout and concrete cone failure												
Calculation diameter d [mm]	8	10	12	14	16	20	22	24	27	30		
Uncracked concrete												
Characteristic bond resistance in uncracked concrete C20/25												
<u>Hammer-drilling with standard drill bit or hollow drill bit (dry and wet concrete)</u>												
Temperature range	I: 35 °C / 60 °C	$\tau_{Rk,ucr}$ [N/mm ²]	16	16	15	14	14	13	13	13	12	12
	II: 50 °C / 72 °C		15	14	14	13	13	12	12	12	11	11
<u>Hammer-drilling with standard drill bit or hollow drill bit (flooded hole)</u>												
Temperature range	I: 35 °C / 60 °C	$\tau_{Rk,ucr}$ [N/mm ²]	16	16	15	13	13	11	11	10	10	9
	II: 50 °C / 72 °C		15	14	14	13	12	11	10	10	9	9
<u>Diamond-drilling (dry and wet concrete as well as flooded hole)</u>												
Temperature range	I: 35 °C / 60 °C	$\tau_{Rk,ucr}$ [N/mm ²]	16	15	13	12	12	10	10	10	9	9
	II: 50 °C / 72 °C		15	14	12	11	11	10	9	9	8	8
Installation safety factors												
Dry and wet concrete	$\gamma_2 = \gamma_{inst}$ [-]	1,0					1,2					
Flooded hole		1,4										
Cracked concrete												
Characteristic bond resistance in cracked concrete C20/25												
<u>Hammer-drilling with standard drill bit or hollow drill bit and diamond-drilling (dry and wet concrete)</u>												
Temperature range	I: 35 °C / 60 °C	$\tau_{Rk,cr}$ [N/mm ²]	7	7	7	7	6	6	7	7	7	7
	II: 50 °C / 72 °C		7	7	7	7	6	6	7	7	7	7
<u>Hammer-drilling with standard drill bit or hollow drill bit and diamond-drilling (flooded hole)</u>												
Temperature range	I: 35 °C / 60 °C	$\tau_{Rk,cr}$ [N/mm ²]	6	7,5	7,5	7	6	6	6	6	6	6
	II: 50 °C / 72 °C		6	7	7	7	6	6	6	6	6	6
Installation safety factors												
Dry and wet concrete	$\gamma_2 = \gamma_{inst}$ [-]	1,0					1,2					
Flooded hole		1,2					1,4					

fischer injection system FIS EM

Performances

Characteristic values for static or quasi-static action under tensile load for fischer anchor rods and standard threaded rods (uncracked or cracked concrete)

Annex C 5

Table C7: Characteristic values of resistance for fischer internal threaded anchors RG MI in hammer or diamond drilled holes; uncracked or cracked concrete								
Size			M8	M10	M12	M16	M20	
Combined pullout and concrete cone failure								
Calculation diameter	d	[mm]	12	16	18	22	28	
Uncracked concrete								
Characteristic bond resistance in uncracked concrete C20/25								
<u>Hammer-drilling with standard drill bit or hollow drill bit (dry and wet concrete)</u>								
Tem- perature range	I: 35 °C / 60 °C	$\tau_{Rk,ucr}$	[N/mm ²]	15	14	14	13	12
	II: 50 °C / 72 °C			14	13	13	12	11
<u>Hammer-drilling with standard drill bit or hollow drill bit (flooded hole)</u>								
Tem- perature range	I: 35 °C / 60 °C	$\tau_{Rk,ucr}$	[N/mm ²]	14	12	12	11	10
	II: 50 °C / 72 °C			13	12	11	10	9
<u>Diamond-drilling (dry and wet concrete as well as flooded hole)</u>								
Tem- perature range	I: 35 °C / 60 °C	$\tau_{Rk,ucr}$	[N/mm ²]	13	12	11	10	9
	II: 50 °C / 72 °C			12	11	10	9	8
Installation safety factors								
Dry and wet concrete	$\gamma_2 = \gamma_{inst}$	[-]	1,0			1,2		
Flooded hole			1,4					
Cracked concrete								
Characteristic bond resistance in cracked concrete C20/25								
<u>Hammer-drilling with standard drill bit or hollow drill bit and diamond-drilling (dry and wet concrete)</u>								
Tem- perature range	I: 35 °C / 60 °C	$\tau_{Rk,cr}$	[N/mm ²]	7	6	6	7	7
	II: 50 °C / 72 °C			7	6	6	7	7
<u>Hammer-drilling with standard drill bit or hollow drill bit and diamond-drilling (flooded hole)</u>								
Tem- perature range	I: 35 °C / 60 °C	$\tau_{Rk,cr}$	[N/mm ²]	7	6,5	6	6	6
	II: 50 °C / 72 °C			7	6	6	6	6
Installation safety factors								
Dry and wet concrete	$\gamma_2 = \gamma_{inst}$	[-]	1,0			1,2		
Flooded hole			1,2			1,4		
fischer injection system FIS EM								
Performances Characteristic values for static or quasi-static action under tensile load for fischer internal threaded anchors RG MI (uncracked or cracked concrete)						Annex C 6		

Table C8: Characteristic values of resistance for reinforcing bars in hammer or diamond drilled holes; uncracked or cracked concrete

Nominal diameter of the bar ϕ		8	10	12	14	16	18	20	22	24	25	26	28	30	32	34	36	40		
Combined pullout and concrete cone failure																				
Calculation diameter d		[mm]	8	10	12	14	16	18	20	22	24	25	26	28	30	32	34	36	40	
Uncracked concrete																				
Characteristic bond resistance in uncracked concrete C20/25																				
Hammer-drilling with standard drill bit or hollow drill bit (dry and wet concrete)																				
Tem- perature range	I: 35 °C / 60 °C	$\tau_{Rk,ucr}$	[N/mm ²]	16	16	15	14	14	14	13	13	13	13	12	12	12	12	12	11	
	II: 50 °C / 72 °C			15	14	14	13	13	13	12	12	12	12	11	11	11	11	11	11	11
Hammer-drilling with standard drill bit or hollow drill bit (flooded hole)																				
Tem- perature range	I: 35 °C / 60 °C	$\tau_{Rk,ucr}$	[N/mm ²]	16	16	14	13	12	12	11	11	10	10	10	10	9	9	9	8	8
	II: 50 °C / 72 °C			15	14	13	12	12	11	11	10	10	9	9	9	9	8	8	8	8
Diamond-drilling (dry and wet concrete as well as flooded hole)																				
Tem- perature range	I: 35 °C / 60 °C	$\tau_{Rk,ucr}$	[N/mm ²]	16	15	13	12	12	11	10	10	10	9	9	9	9	8	8	8	7
	II: 50 °C / 72 °C			15	14	12	11	11	10	10	9	9	9	8	8	8	8	7	7	7
Installation safety factors																				
Dry and wet concrete		$\gamma_2 = \gamma_{inst}$	[-]	1,0								1,2								
Flooded hole				1,4																
Cracked concrete																				
Characteristic bond resistance in cracked concrete C20/25																				
Hammer-drilling with standard drill bit or hollow drill bit and diamond-drilling (dry and wet concrete)																				
Tem- perature range	I: 35 °C / 60 °C	$\tau_{Rk,cr}$	[N/mm ²]	7	7	7	7	6	6	6	7	7	7	7	7	7	5	5	5	5
	II: 50 °C / 72 °C			7	7	7	7	6	6	6	7	7	7	7	7	7	5	5	5	5
Hammer-drilling with standard drill bit or hollow drill bit and diamond-drilling (flooded hole)																				
Tem- perature range	I: 35 °C / 60 °C	$\tau_{Rk,cr}$	[N/mm ²]	6	7,5	6,5	6,5	6,5	6	6	6	6	6	6	6	6	5	5	5	5
	II: 50 °C / 72 °C			6	6,5	6,5	6	6	6	6	6	6	6	6	6	6	5	5	5	5
Installation safety factors																				
Dry and wet concrete		$\gamma_2 = \gamma_{inst}$	[-]	1,0								1,2								
Flooded hole				1,2				1,4												

fischer injection system FIS EM

Performances

Characteristic values for static or quasi-static action under tensile load for reinforcing bars (uncracked or cracked concrete)

Annex C 7

Table C9: Characteristic values of resistance for fischer rebar anchors FRA in hammer or diamond drilled holes; uncracked or cracked concrete

Size	M12	M16	M20	M24	
Combined pullout and concrete cone failure					
Calculation diameter d [mm]	12	16	20	25	
Uncracked concrete					
Characteristic bond resistance in uncracked concrete C20/25					
<u>Hammer-drilling with standard drill bit or hollow drill bit (dry and wet concrete)</u>					
Temperature range I: 35 °C / 60 °C II: 50 °C / 72 °C	$\tau_{Rk,ucr}$ [N/mm ²]	15	14	13	13
		14	13	12	12
<u>Hammer-drilling with standard drill bit or hollow drill bit (flooded hole)</u>					
Temperature range I: 35 °C / 60 °C II: 50 °C / 72 °C	$\tau_{Rk,ucr}$ [N/mm ²]	14	12	11	10
		13	12	11	9
<u>Diamond-drilling (dry and wet concrete as well as flooded hole)</u>					
Temperature range I: 35 °C / 60 °C II: 50 °C / 72 °C	$\tau_{Rk,ucr}$ [N/mm ²]	13	12	10	9
		12	11	10	9
Installation safety factors					
Dry and wet concrete	$\gamma_2 = \gamma_{inst}$ [-]	1,0			1,2
Flooded hole		1,4			
Cracked concrete					
Characteristic bond resistance in cracked concrete C20/25					
<u>Hammer-drilling with standard drill bit or hollow drill bit and diamond-drilling (dry and wet concrete)</u>					
Temperature range I: 35 °C / 60 °C II: 50 °C / 72 °C	$\tau_{Rk,cr}$ [N/mm ²]	7	6	6	7
		7	6	6	7
<u>Hammer-drilling with standard drill bit or hollow drill bit and diamond-drilling (flooded hole)</u>					
Temperature range I: 35 °C / 60 °C II: 50 °C / 72 °C	$\tau_{Rk,cr}$ [N/mm ²]	7	6	6	6
		7	6	6	6
Installation safety factors					
Dry and wet concrete	$\gamma_2 = \gamma_{inst}$ [-]	1,0			1,2
Flooded hole		1,2		1,4	
fischer injection system FIS EM				Annex C 8	
Performances Characteristic values for static or quasi-static action under tensile load for fischer rebar anchors FRA (uncracked or cracked concrete)					

Table C10: Displacements for anchor rods

Size	M8	M10	M12	M14	M16	M20	M22	M24	M27	M30	
Displacement-Factors for tensile load¹⁾											
Uncracked or cracked concrete; Temperature range I, II											
δ_{N0} -Factor	[mm/(N/mm ²)]	0,07	0,08	0,09	0,09	0,10	0,11	0,11	0,12	0,12	0,13
$\delta_{N\infty}$ -Factor		0,11	0,12	0,13	0,14	0,15	0,16	0,17	0,18	0,19	0,19
Displacement-Factors for shear load²⁾											
Uncracked or cracked concrete; Temperature range I, II											
δ_{V0} -Factor	[mm/kN]	0,18	0,15	0,12	0,10	0,09	0,07	0,07	0,06	0,05	0,05
$\delta_{V\infty}$ -Factor		0,27	0,22	0,18	0,16	0,14	0,11	0,10	0,09	0,08	0,07
¹⁾ Calculation of effective displacement: $\delta_{N0} = \delta_{N0}\text{-Factor} \cdot \tau_{Ed}$ $\delta_{N\infty} = \delta_{N\infty}\text{-Factor} \cdot \tau_{Ed}$ (τ_{Ed} : Design value of the applied tensile stress)						²⁾ Calculation of effective displacement: $\delta_{V0} = \delta_{V0}\text{-Factor} \cdot V_{Ed}$ $\delta_{V\infty} = \delta_{V\infty}\text{-Factor} \cdot V_{Ed}$ (V_{Ed} : Design value of the applied shear force)					

Table C11: Displacements for fischer internal threaded anchors RG MI

Size	M8	M10	M12	M16	M20	
Displacement-Factors for tensile load¹⁾						
Uncracked or cracked concrete; Temperature range I, II						
δ_{N0} -Factor	[mm/(N/mm ²)]	0,09	0,10	0,10	0,11	0,13
$\delta_{N\infty}$ -Factor		0,13	0,15	0,16	0,17	0,19
Displacement-Factors for shear load²⁾						
Uncracked or cracked concrete; Temperature range I, II						
δ_{V0} -Factor	[mm/kN]	0,12	0,09	0,08	0,07	0,05
$\delta_{V\infty}$ -Factor		0,18	0,14	0,12	0,10	0,08
¹⁾ Calculation of effective displacement: $\delta_{N0} = \delta_{N0}\text{-Factor} \cdot \tau_{Ed}$ $\delta_{N\infty} = \delta_{N\infty}\text{-Factor} \cdot \tau_{Ed}$ (τ_{Ed} : Design value of the applied tensile stress)			²⁾ Calculation of effective displacement: $\delta_{V0} = \delta_{V0}\text{-Factor} \cdot V_{Ed}$ $\delta_{V\infty} = \delta_{V\infty}\text{-Factor} \cdot V_{Ed}$ (V_{Ed} : Design value of the applied shear force)			

fischer injection system FIS EM

Performances

Displacements for anchor rods and fischer internal threaded anchors RG MI

Annex C 9

Table C12: Displacements for reinforcing bars

Nominal diameter of the bar ϕ		8	10	12	14	16	18	20	22	24	25	26	28	30	32	34	36	40
Displacement-Factors for tensile load¹⁾																		
Uncracked or cracked concrete; Temperature range I, II																		
δ_{N0} -Factor	[mm/(N/mm ²)]	0,07	0,08	0,09	0,09	0,10	0,10	0,11	0,11	0,12	0,12	0,12	0,13	0,13	0,13	0,14	0,14	0,15
$\delta_{N\infty}$ -Factor		0,11	0,12	0,13	0,14	0,15	0,16	0,16	0,17	0,18	0,18	0,18	0,19	0,19	0,20	0,20	0,21	0,22
Displacement-Factors for shear load²⁾																		
Uncracked or cracked concrete; Temperature range I, II																		
δ_{V0} -Factor	[mm/kN]	0,18	0,15	0,12	0,10	0,09	0,08	0,07	0,07	0,06	0,06	0,06	0,05	0,05	0,05	0,04	0,04	0,04
$\delta_{V\infty}$ -Factor		0,27	0,22	0,18	0,16	0,14	0,12	0,11	0,10	0,09	0,09	0,08	0,08	0,07	0,07	0,06	0,06	0,05

1) Calculation of effective displacement:

$$\delta_{N0} = \delta_{N0\text{-Factor}} \cdot \tau_{Ed}$$

$$\delta_{N\infty} = \delta_{N\infty\text{-Factor}} \cdot \tau_{Ed}$$

(τ_{Ed} : Design value of the applied tensile stress)

2) Calculation of effective displacement:

$$\delta_{V0} = \delta_{V0\text{-Factor}} \cdot V_{Ed}$$

$$\delta_{V\infty} = \delta_{V\infty\text{-Factor}} \cdot V_{Ed}$$

(V_{Ed} : Design value of the applied shear force)

Table C13: Displacements for fischer rebar anchors FRA

Size		M12	M16	M20	M24
Displacement-Factors for tensile load¹⁾					
Uncracked or cracked concrete; Temperature range I, II					
δ_{N0} -Factor	[mm/(N/mm ²)]	0,09	0,10	0,11	0,12
$\delta_{N\infty}$ -Factor		0,13	0,15	0,16	0,18
Displacement-Factors for shear load²⁾					
Uncracked or cracked concrete; Temperature range I, II					
δ_{V0} -Factor	[mm/kN]	0,12	0,09	0,07	0,06
$\delta_{V\infty}$ -Factor		0,18	0,14	0,11	0,09

1) Calculation of effective displacement:

$$\delta_{N0} = \delta_{N0\text{-Factor}} \cdot \tau_{Ed}$$

$$\delta_{N\infty} = \delta_{N\infty\text{-Factor}} \cdot \tau_{Ed}$$

(τ_{Ed} : Design value of the applied tensile stress)

2) Calculation of effective displacement:

$$\delta_{V0} = \delta_{V0\text{-Factor}} \cdot V_{Ed}$$

$$\delta_{V\infty} = \delta_{V\infty\text{-Factor}} \cdot V_{Ed}$$

(V_{Ed} : Design value of the applied shear force)

fischer injection system FIS EM

Performances

Displacements for reinforcing bars and fischer rebar anchors FRA

Annex C 10

Table C15: Characteristic values for the steel bearing capacity under tensile / shear load of reinforcing bars (B500B) under seismic action performance category C1

Nominal diameter of the bar	ϕ	10	12	14	16	18	20	22	24	25	26	28	30	32	
Bearing capacity under tensile load, steel failure¹⁾															
Reinforcing bar B500B acc. to DIN 488-2:2009-08, performance category C1															
Characteristic bearing capacity	$N_{Rk,s,C1}$	[kN]	44	63	85	111	140	173	209	249	270	292	339	389	443
Bearing capacity under shear load, steel failure without lever arm¹⁾															
Reinforcing bar B500B acc. to DIN 488-2:2009-08, performance category C1															
Characteristic bearing capacity	$V_{Rk,s,C1}$	[kN]	15	22	30	39	49	61	74	88	95	102	119	137	155

¹⁾ Partial safety factors for performance category C1 see Table C16

Table C16: Partial safety factors of fischer anchor rods, standard threaded rods and reinforcing bars (B500B) under seismic action performance category C1 or C2

Size	M10	M12	M14	M16	M20	M22	M24	M27	M30					
Nominal diameter of the bar	ϕ	10	12	14	16	18	20	22	24	25	26	28	30	32
Bearing capacity under tensile load, steel failure¹⁾														
Partial safety factor $\gamma_{Ms,N}$	Steel zinc plated	Property class	5.8	[-]	1,50									
			8.8		1,50									
	Stainless steel A4 and High corrosion resistant steel C	50	2,86											
		70	1,50 ²⁾ / 1,87											
		80	1,60											
	Reinforcing bar	B500B	1,40											
Bearing capacity under shear load, steel failure¹⁾														
Partial safety factor $\gamma_{Ms,V}$	Steel zinc plated	Property class	5.8	[-]	1,25									
			8.8		1,25									
	Stainless steel A4 and High corrosion resistant steel C		50		2,38									
			70		1,25 ²⁾ / 1,56									
			80		1,33									
	Reinforcing bar		B500B		1,50									

¹⁾ In absence of other national regulations

²⁾ Only admissible for steel C, with $f_{yk} / f_{uk} \geq 0,8$ and $A_5 > 12\%$ (e.g. fischer anchor rods)

fischer injection system FIS EM

Performances

Characteristic steel bearing capacity of reinforcing bars under seismic action (performance category C1); partial safety factors (performance category C1 or C2)

Annex C 12

Table C17: Characteristic values of **resistance** for **fischer anchor rods** and **standard threaded rods** in hammer drilled holes under seismic action performance category **C1**

Size	M10	M12	M14	M16	M20	M22	M24	M27	M30					
Characteristic bond resistance, combined pullout and concrete cone failure														
Hammer-drilling with standard drill bit or hollow drill bit (dry and wet concrete)														
Tem- perature range	I: 35 °C / 60 °C	$\tau_{Rk,C1}$	[N/mm ²]	7,0	7,0	6,7	6,0	5,7	6,7	6,7	6,7	6,7	6,7	6,7
	II: 50 °C / 72 °C			7,0	7,0	6,7	5,7	5,7	6,7	6,7	6,7	6,7	6,7	6,7
Hammer-drilling with standard drill bit or hollow drill bit (flooded hole)														
Tem- perature range	I: 35 °C / 60 °C	$\tau_{Rk,C1}$	[N/mm ²]	7,5	7,5	6,5	5,7	5,7	5,7	5,7	5,7	5,7	5,7	5,7
	II: 50 °C / 72 °C			6,8	6,8	6,5	5,7	5,7	5,7	5,7	5,7	5,7	5,7	5,7
Installation safety factors														
Bearing capacity under tensile load														
Dry and wet concrete	$\gamma_2 = \gamma_{inst}$	[-]	1,0				1,2							
Flooded hole			1,2				1,4							
Bearing capacity under shear load														
All installation conditions	$\gamma_2 = \gamma_{inst}$	[-]	1,0											

Table C18: Characteristic values of **resistance** for **reinforcing bars** in hammer drilled holes under seismic action performance category **C1**

Nominal diameter of the bar	ϕ	10	12	14	16	18	20	22	24	25	26	28	30	32	
Characteristic bond resistance, combined pullout and concrete cone failure															
Hammer-drilling with standard drill bit or hollow drill bit (dry and wet concrete)															
Tem- perature range	I: 35 °C / 60 °C	$\tau_{Rk,C1}$	[N/mm ²]	7,0	7,0	6,7	5,7	5,7	5,7	6,7	6,7	6,7	6,7	6,7	4,8
	II: 50 °C / 72 °C			7,0	7,0	6,7	5,7	5,7	5,7	6,7	6,7	6,7	6,7	6,7	6,7
Hammer-drilling with standard drill bit or hollow drill bit (flooded hole)															
Tem- perature range	I: 35 °C / 60 °C	$\tau_{Rk,C1}$	[N/mm ²]	7,5	6,5	6,5	5,7	5,7	5,7	5,7	5,7	5,7	5,7	4,8	
	II: 50 °C / 72 °C			6,5	6,5	5,8	5,8	5,7	5,7	5,7	5,7	5,7	5,7	5,7	4,8
Installation safety factors															
Bearing capacity under tensile load															
Dry and wet concrete	$\gamma_2 = \gamma_{inst}$	[-]	1,0				1,2								
Flooded hole			1,2				1,4								
Bearing capacity under shear load															
All installation conditions	$\gamma_2 = \gamma_{inst}$	[-]	1,0												

fischer injection system FIS EM

Performances

Characteristic values under seismic action (performance category C1) for fischer anchor rods, standard threaded rods and reinforcing bars

Annex C 13

Table C19: Characteristic values of **resistance** for **fischer anchor rods** and **standard threaded rods** in hammer drilled holes under seismic action performance category **C2**

Size		M12	M16	M20	M24	
Characteristic bond resistance, combined pullout and concrete cone failure						
Hammer-drilling with standard drill bit or hollow drill bit (dry and wet concrete)						
Tem- perature range	I: 35 °C / 60 °C	$\tau_{Rk,C2}$ [N/mm ²]	2,2	3,5	1,8	2,4
	II: 50 °C / 72 °C		2,2	3,5	1,8	2,4
Hammer-drilling with standard drill bit or hollow drill bit (flooded hole)						
Tem- perature range	I: 35 °C / 60 °C	$\tau_{Rk,C2}$ [N/mm ²]	2,3	3,5	1,8	2,1
	II: 50 °C / 72 °C		2,3	3,5	1,8	2,1
Installation safety factors						
Bearing capacity under tensile load						
Dry and wet concrete		$\gamma_2 = \gamma_{inst}$ [-]	1,0			1,2
Flooded hole			1,2	1,4		
Bearing capacity under shear load						
All installation conditions		$\gamma_2 = \gamma_{inst}$ [-]	1,0			
Displacement-Factors for tensile load¹⁾						
$\delta_{N,(DLS)}$ -Factor		[mm/(N/mm ²)]	0,09	0,10	0,11	0,12
$\delta_{N,(ULS)}$ -Factor			0,15	0,17	0,17	0,18
Displacement-Factors for shear load²⁾						
$\delta_{V,(DLS)}$ -Factor		[mm/kN]	0,18	0,10	0,07	0,06
$\delta_{V,(ULS)}$ -Factor			0,25	0,14	0,11	0,09

1) Calculation of effective displacement:

$$\delta_{N,(DLS)} = \delta_{N,(DLS)\text{-Factor}} \cdot \tau_{Ed}$$

$$\delta_{N,(ULS)} = \delta_{N,(ULS)\text{-Factor}} \cdot \tau_{Ed}$$

(τ_{Ed} : Design value of the applied tensile stress)

2) Calculation of effective displacement:

$$\delta_{V,(DLS)} = \delta_{V,(DLS)\text{-Factor}} \cdot V_{Ed}$$

$$\delta_{V,(ULS)} = \delta_{V,(ULS)\text{-Factor}} \cdot V_{Ed}$$

(V_{Ed} : Design value of the applied shear force)

fischer injection system FIS EM

Performances

Characteristic values under seismic action (performance category C2) for fischer anchor rods and standard threaded rods

Annex C 14